

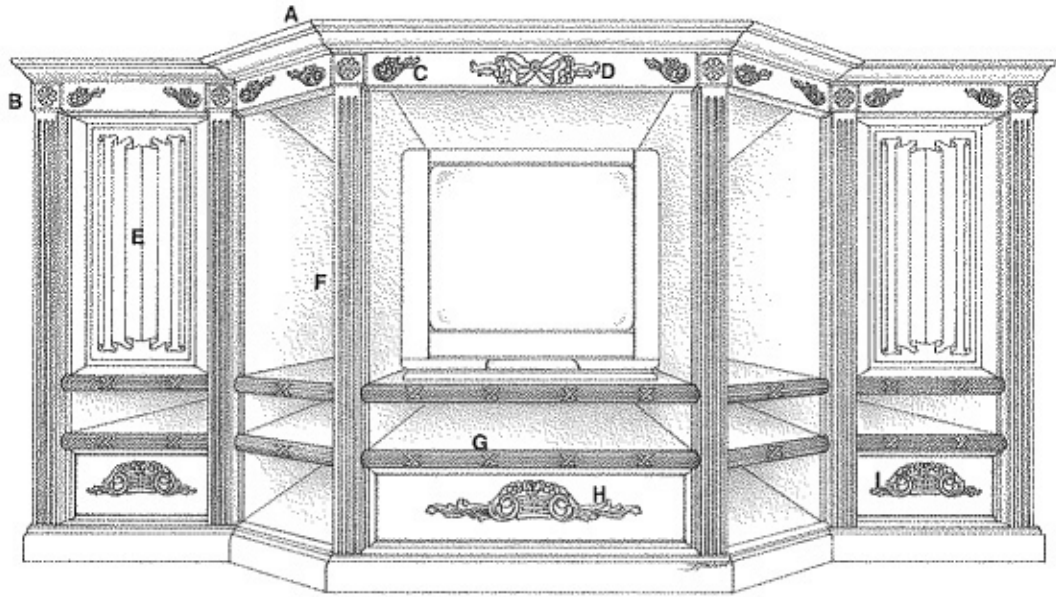

Botto 2

dizains





- A. MLD-PC6
- B. ROS-FC0
- C. ONL-FT0
- D. ONL-RH2
- E. PNL-LM3
- F. CLM-FS2
- G. MLD-RA2
- H. PUL-FO3
- I. PUL-FO1
- J. MLD-PO3
- K. MLD-RB5
- L. ONL-RT3
- M. ROS-FC2

- N. ROS-FC1
- O. ARC-PL4
- P. ARC-PL3
- Q. ONL-FP5
- R. PNL-LN3
- S. MLD-LC5
- T. CLM-FD4
- U. MLD-PO2
- V. PLI-PB5
- W. CPL-CP4
- X. CLM-FD4
- Y. CLM-PD4
- Z. MLD-LC5

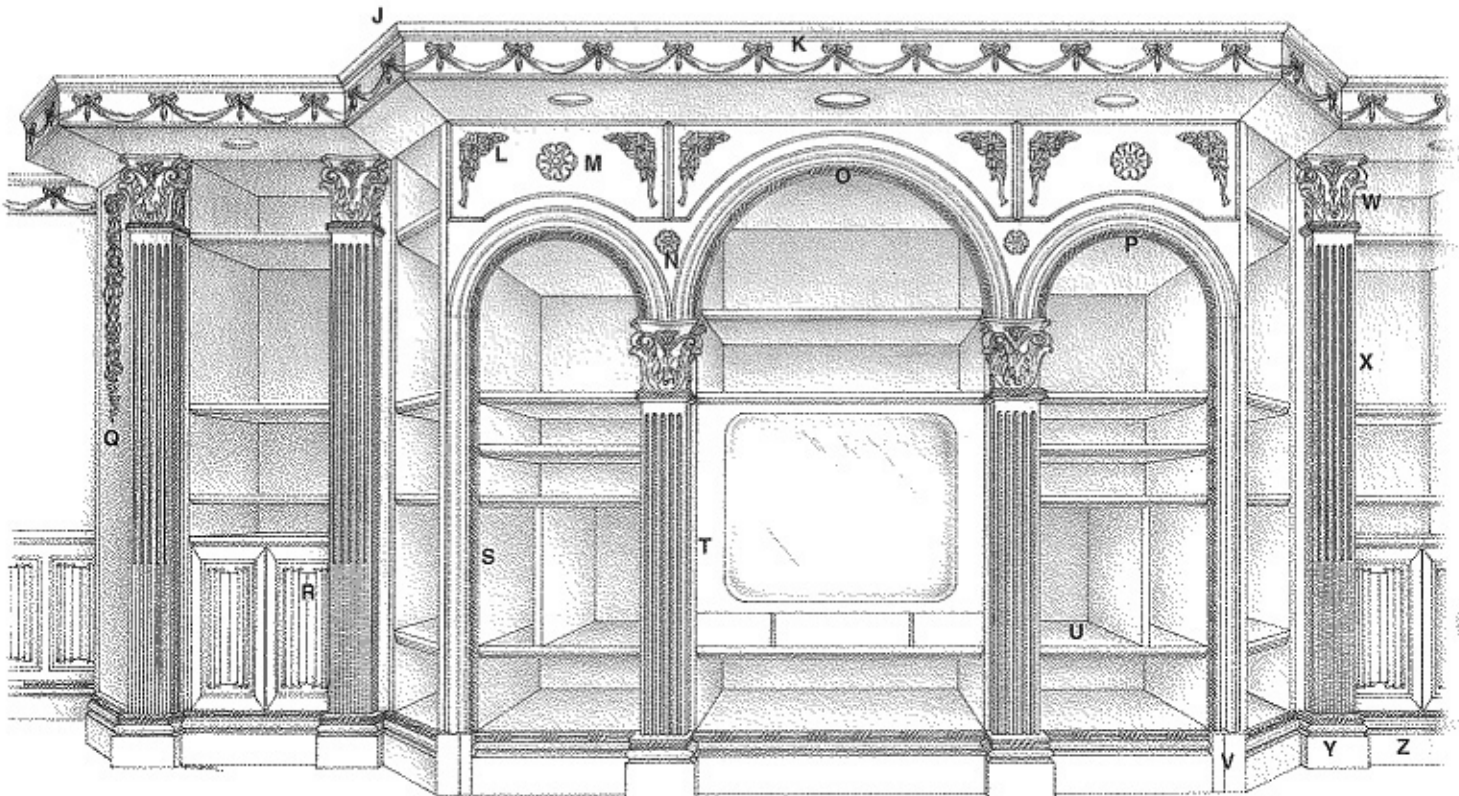

- A. MLD-PO2
- B. MLD-OO3
- C. BLR-TF3
- D. PNL-OW3
- E. CLM-FP2
- F. PNL-OM2
- G. CLM-FP1
- H. MLD-PO3
- I. MLD-FC6
- J. ONL-RH5
- K. CBL-FP1
- L. PNL-FN3
- M. ROS-FC1
- N. MLD-PO2
- O. PUL-DR0
- P. ONL-RM2
- Q. PNL-FM2
- R. MLD-LB3

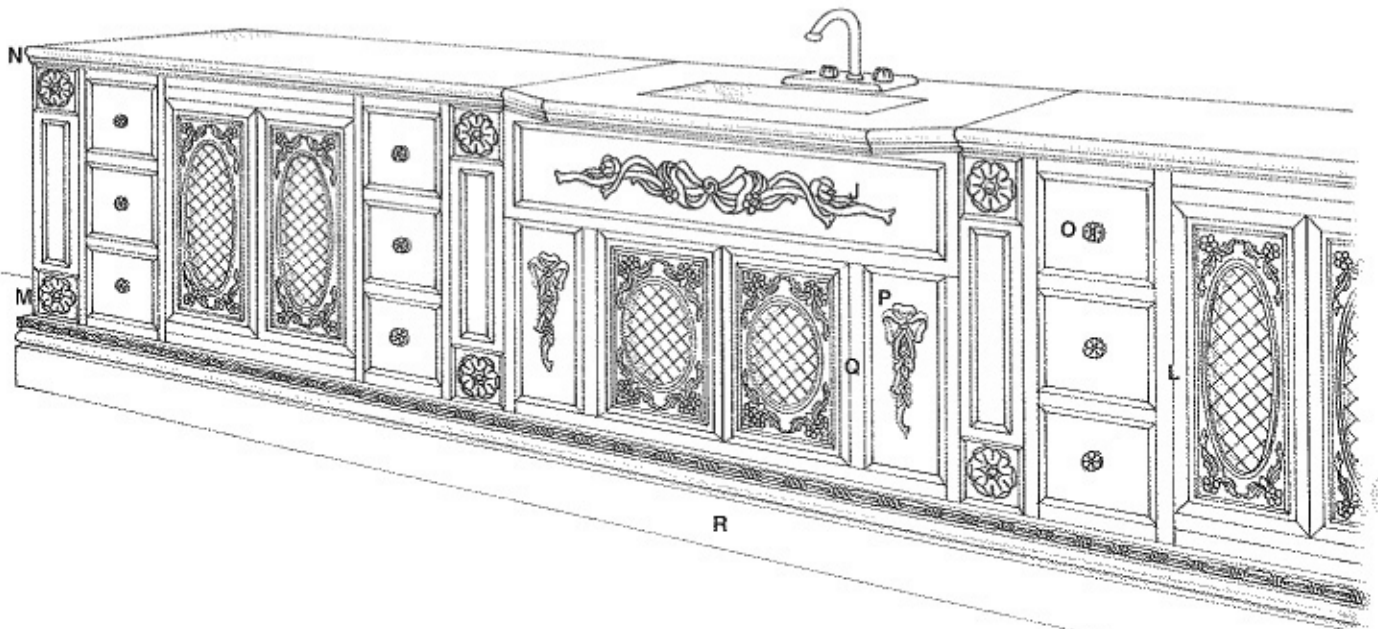
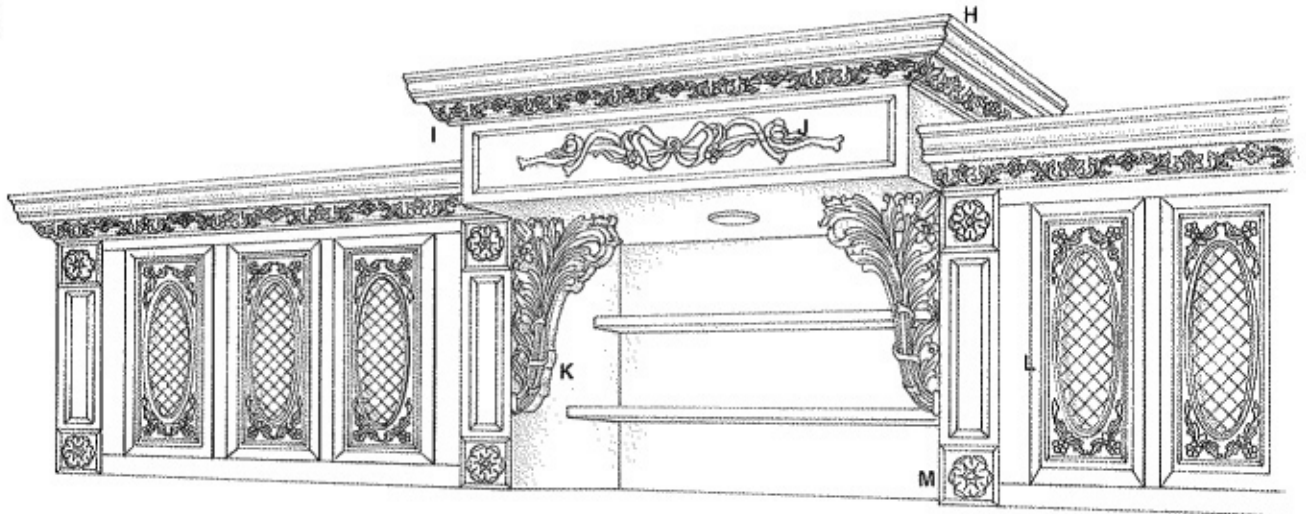
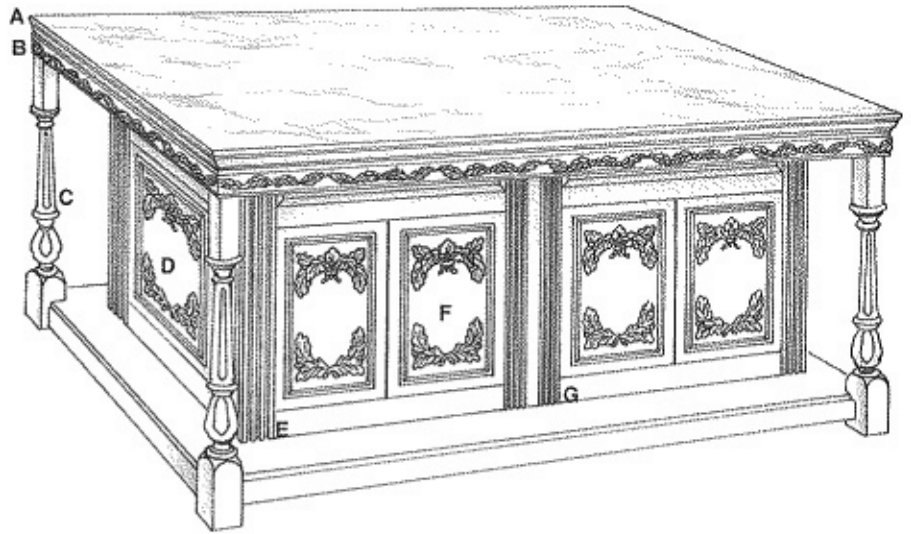

- A. MLD-E04
- B. MLD-PC9
- C. MLD-DO3
- D. MLD-GP3
- E. MLD-LC5
- F. ONL-GH5
- G. ONL-GM2
- H. MLD-LC3
- I. MLD-DO1
- J. ONL-GO1
- K. ONL-GM4
- L. ONL-GT2
- M. PNL-GN3
- N. PNL-GW3
- O. ARC-EL6
- P. MLD-FA3
- Q. ONL-FG4
- R. ONL-RH4
- S. ROS-AS1

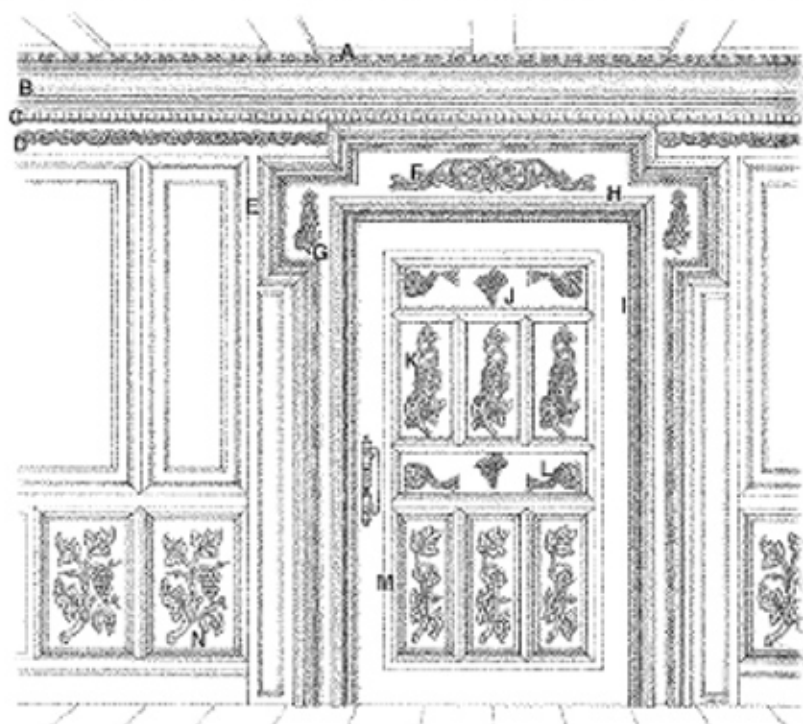

- T. ONL-FP5
- U. CPL-CP4
- V. CLM-FD4

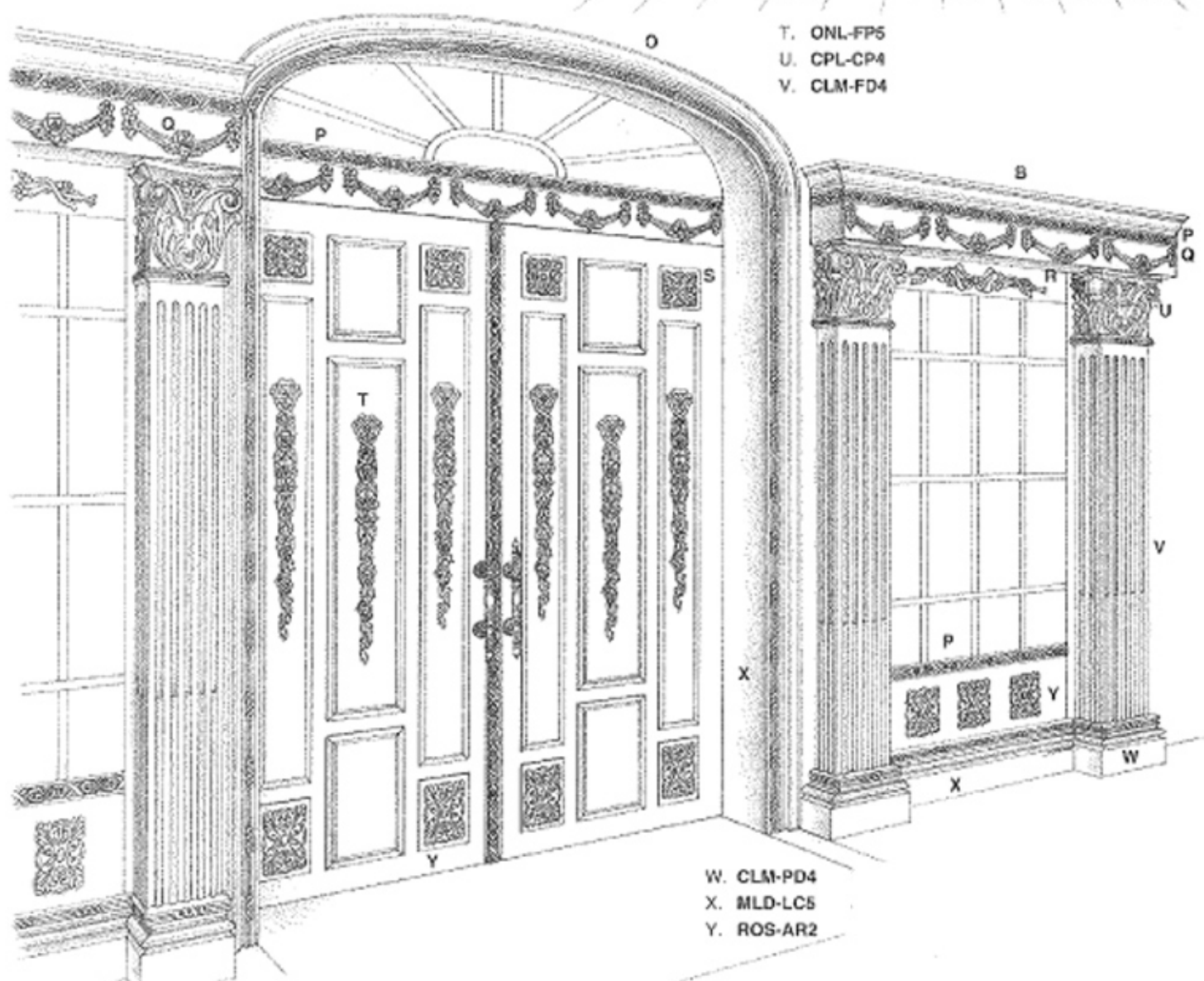

- W. CLM-PD4
- X. MLD-LC5
- Y. ROS-AR2

- A. KEY-SO5
- B. ARC-OL5
- C. MLD-LC5

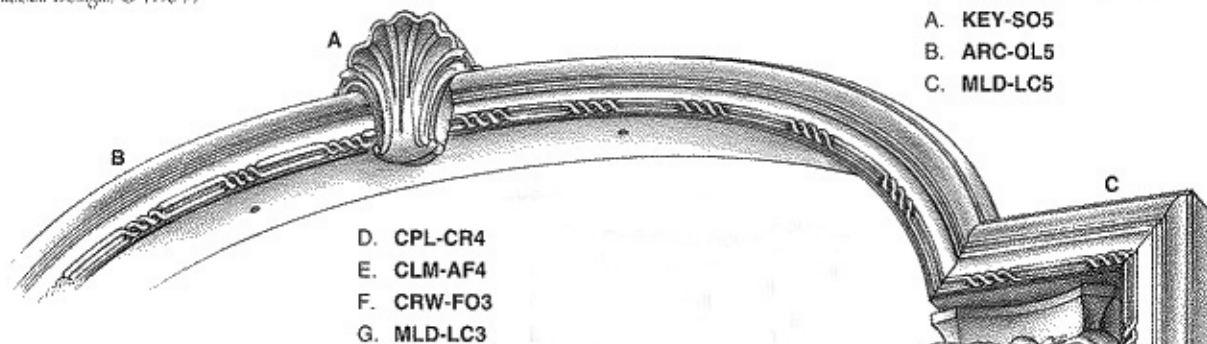

- D. CPL-CR4
- E. CLM-AF4
- F. CRW-FO3
- G. MLD-LC3

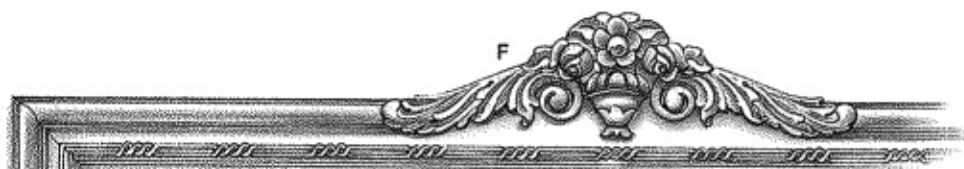

- H. MLD-PO1
- I. ARC-SL4
- J. MLD-LC5

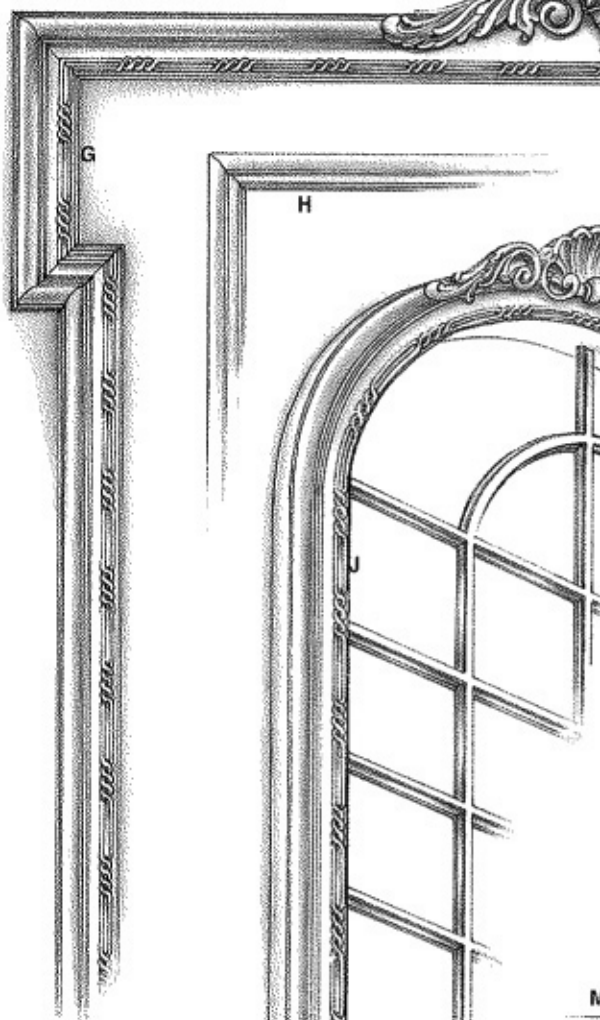

- K. KEY-CB5
- L. ARC-PL4
- M. MLD-PT3

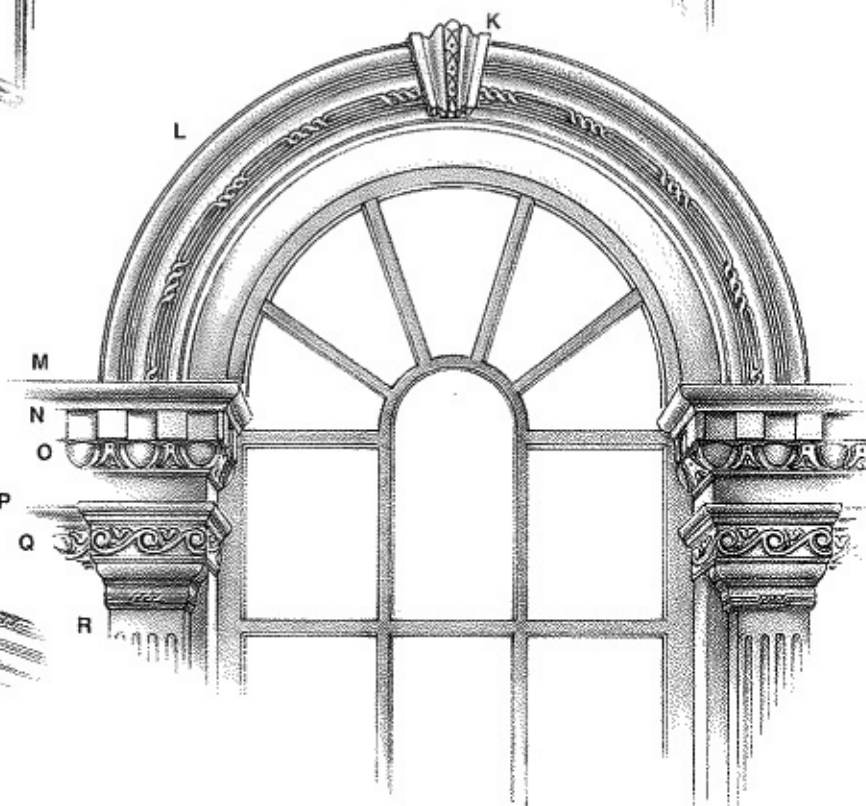

- N. MLD-DO3
- O. MLD-EO3
- P. MLD-PO0
- Q. MLD-SW3
- R. CLM-FP3

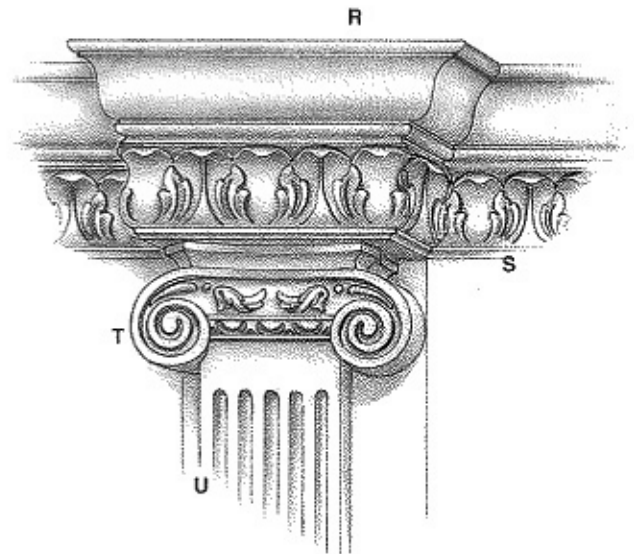
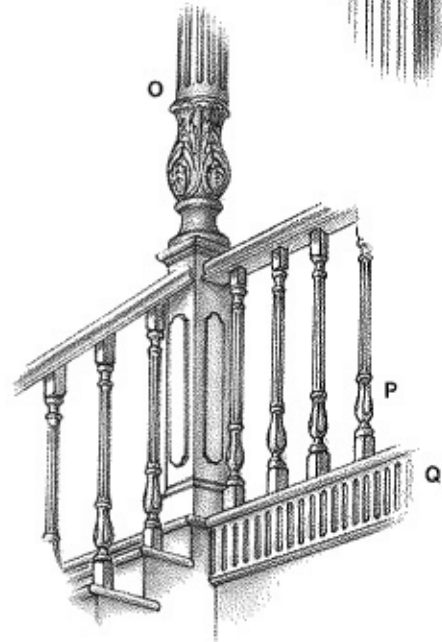
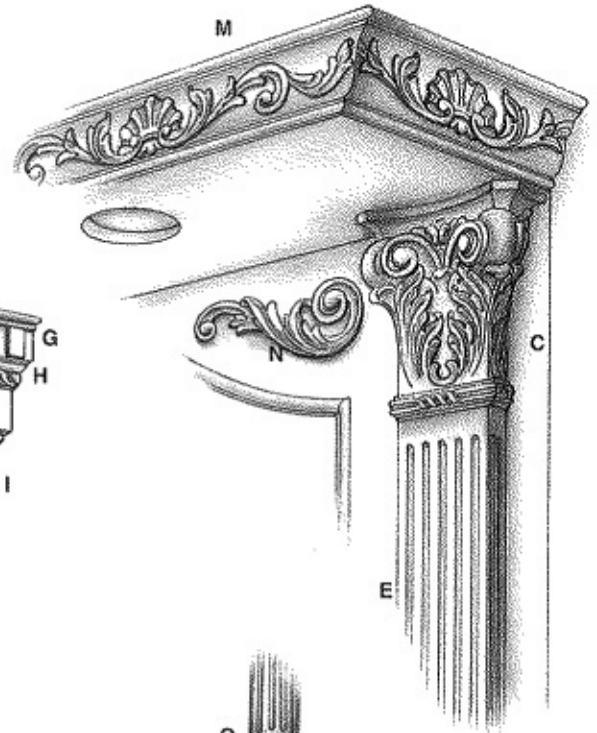
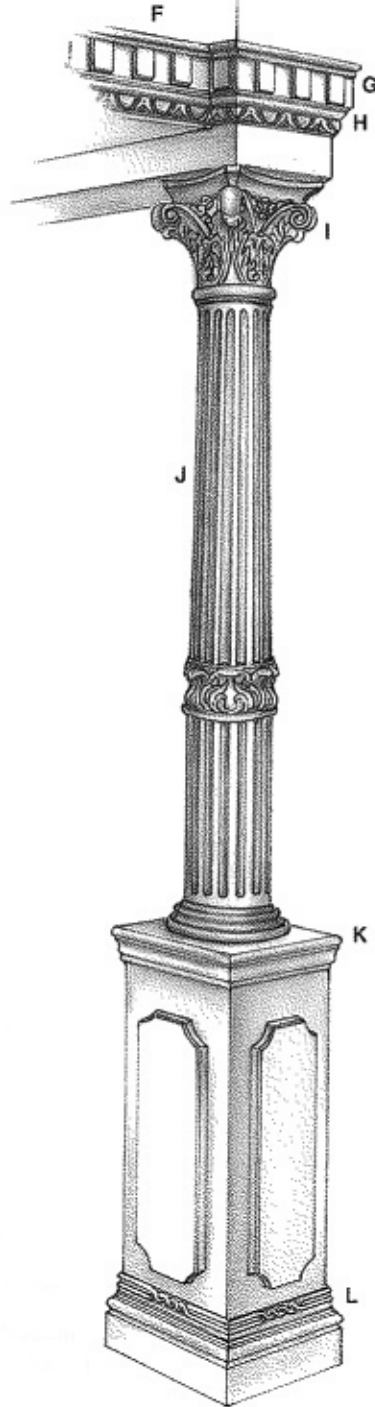
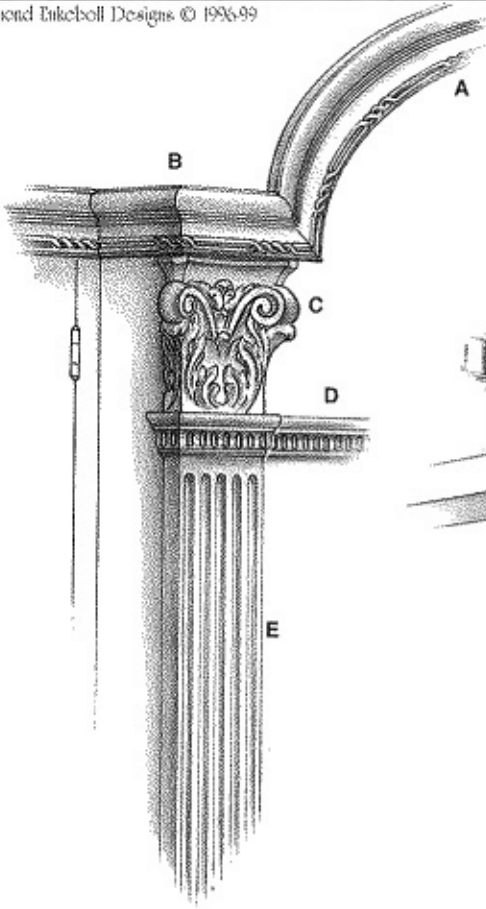

- A. ARC-EL6
- B. MLD-LC5
- C. CPL-CP4
- D. MLD-FL3
- E. CLM-FP4

- F. MLD-PT1
- G. MLD-DO4
- H. MLD-EO4
- I. CPL-CR4
- J. CLM-AF4
- K. MLD-PO3

- L. MLD-LC3
- M. MLD-SC6
- N. ONL-AT3
- O. CLM-AF2
- P. BLR-TF2
- Q. MLD-FL5
- R. MLD-PC9
- S. MLD-AB5
- T. CPL-IP4
- U. CLM-FP4

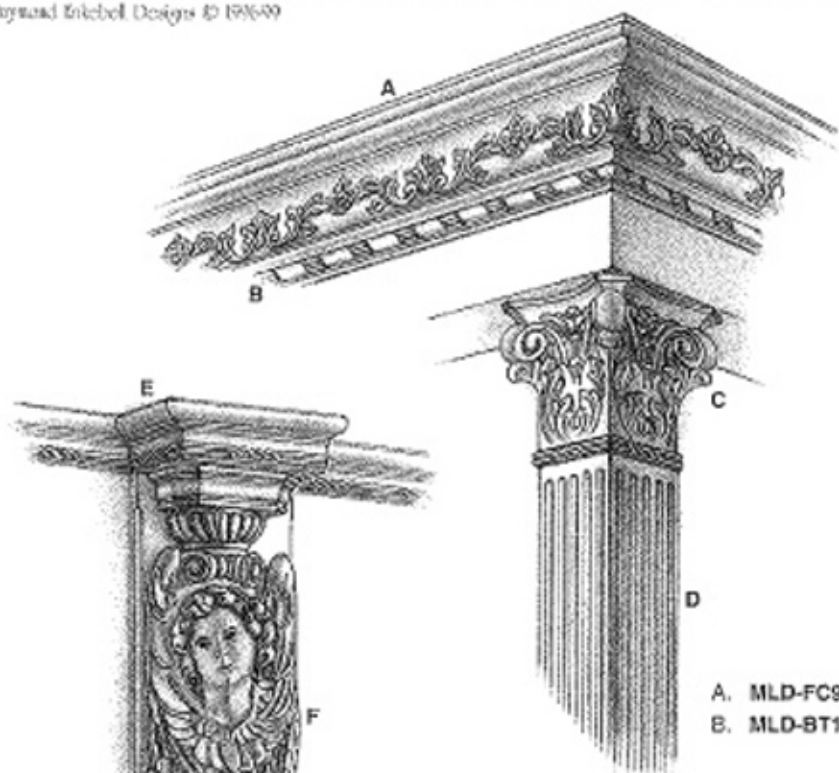

A. MLD-FC9
 B. MLD-BT1

C. CPL-CS4
 D. CLM-FS4

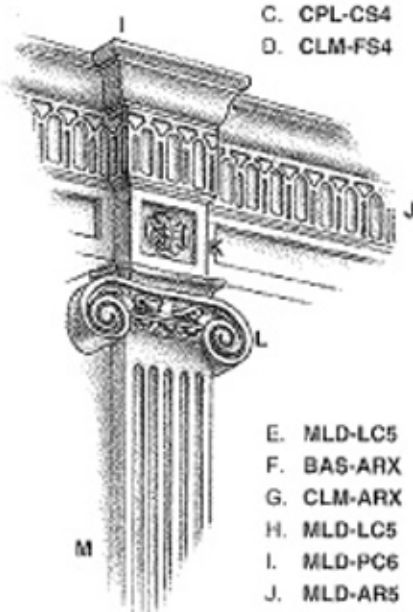

E. MLD-LC5
 F. BAS-ARX
 G. CLM-ARX
 H. MLD-LC5
 I. MLD-PC6
 J. MLD-AR5

K. ROS-FC1
 L. CPL-IP4
 M. CLM-FP4

N. MLD-AC9
 O. CPL-CR4
 P. CLM-AF4
 Q. CLM-PP6

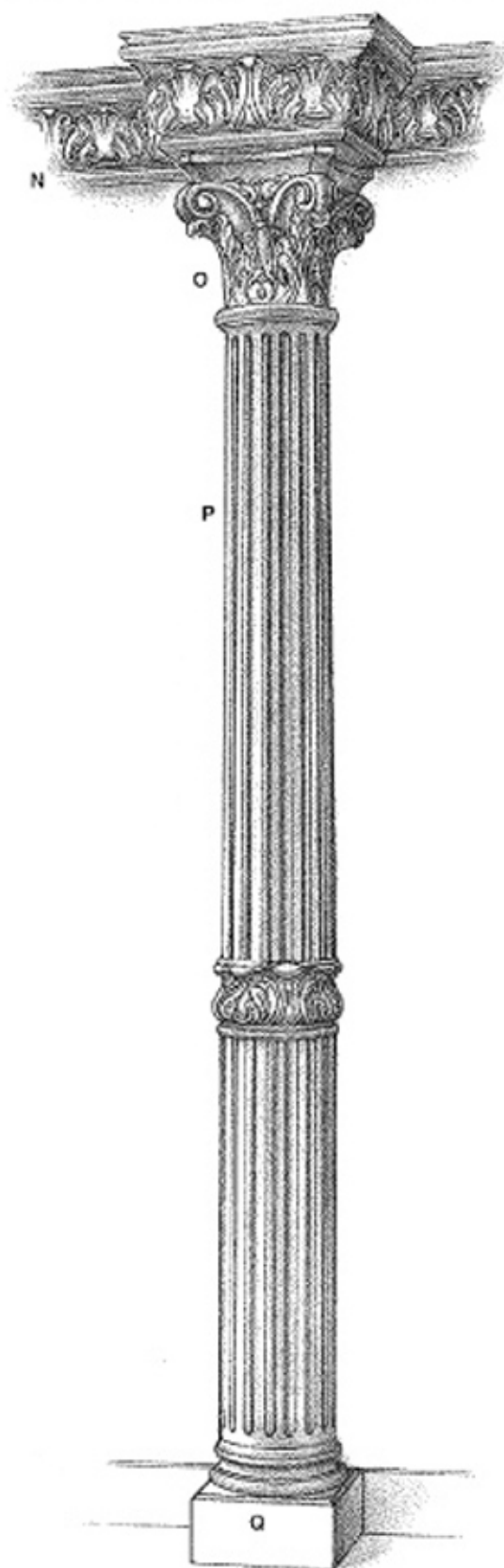

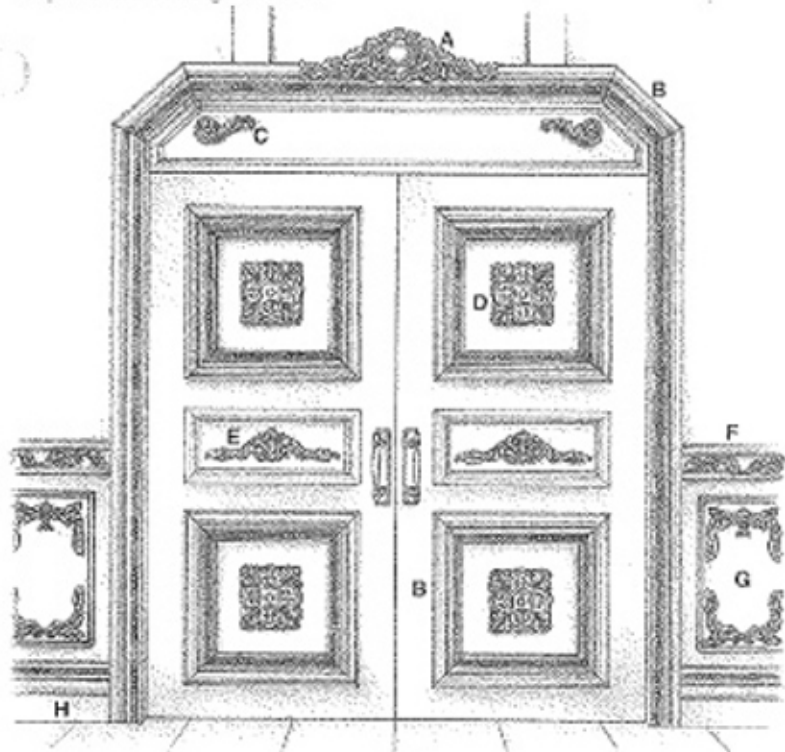

- A. CRW-005
- B. MLD-LC5
- C. ONL-AT3
- D. ROS-AS3
- E. ONL-AH4
- F. MLD-OB5
- G. PNL-OW3
- H. MLD-LC5
- I. MLD-PC9
- J. MLD-EO4
- K. CBL-AD1
- L. MLD-FL3
- M. CRW-SX5
- N. CLM-ARX
- O. CLM-ALX
- P. ROS-AR3
- Q. MLD-LC5
- R. PNL-SN3
- S. MLD-LA3

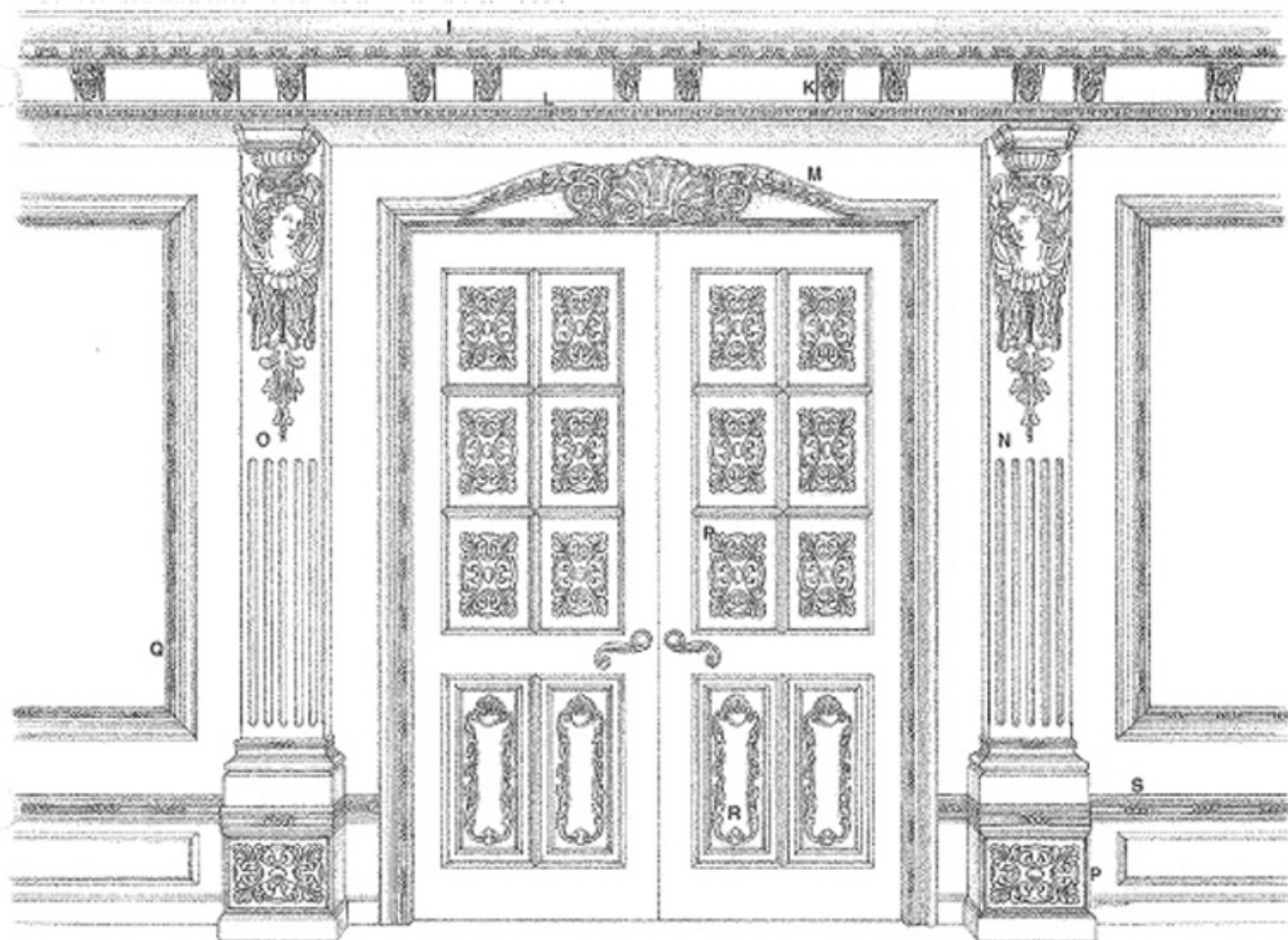

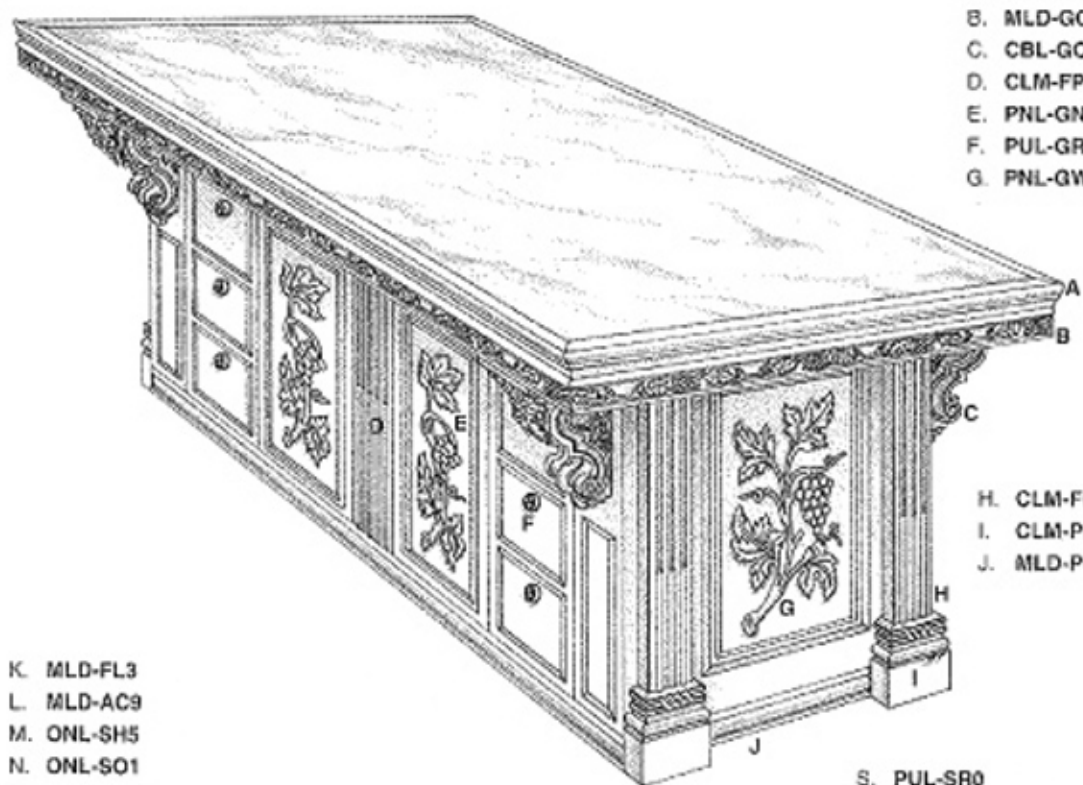

- A. MLD-PT1
- B. MLD-GO3
- C. CBL-GO2
- D. CLM-FP3
- E. PNL-GN3
- F. PUL-GR0
- G. PNL-GW3

- H. CLM-FP2
- I. CLM-PP2
- J. MLD-PO3

- K. MLD-FL3
- L. MLD-AC9
- M. ONL-SH5
- N. ONL-SO1
- O. ROS-AS3
- P. PNL-SN2
- Q. CLM-FD3
- R. MLD-PO3

- S. PUL-SR0
- T. PNL-SW3
- U. PUL-SO3
- V. BLR-AF3

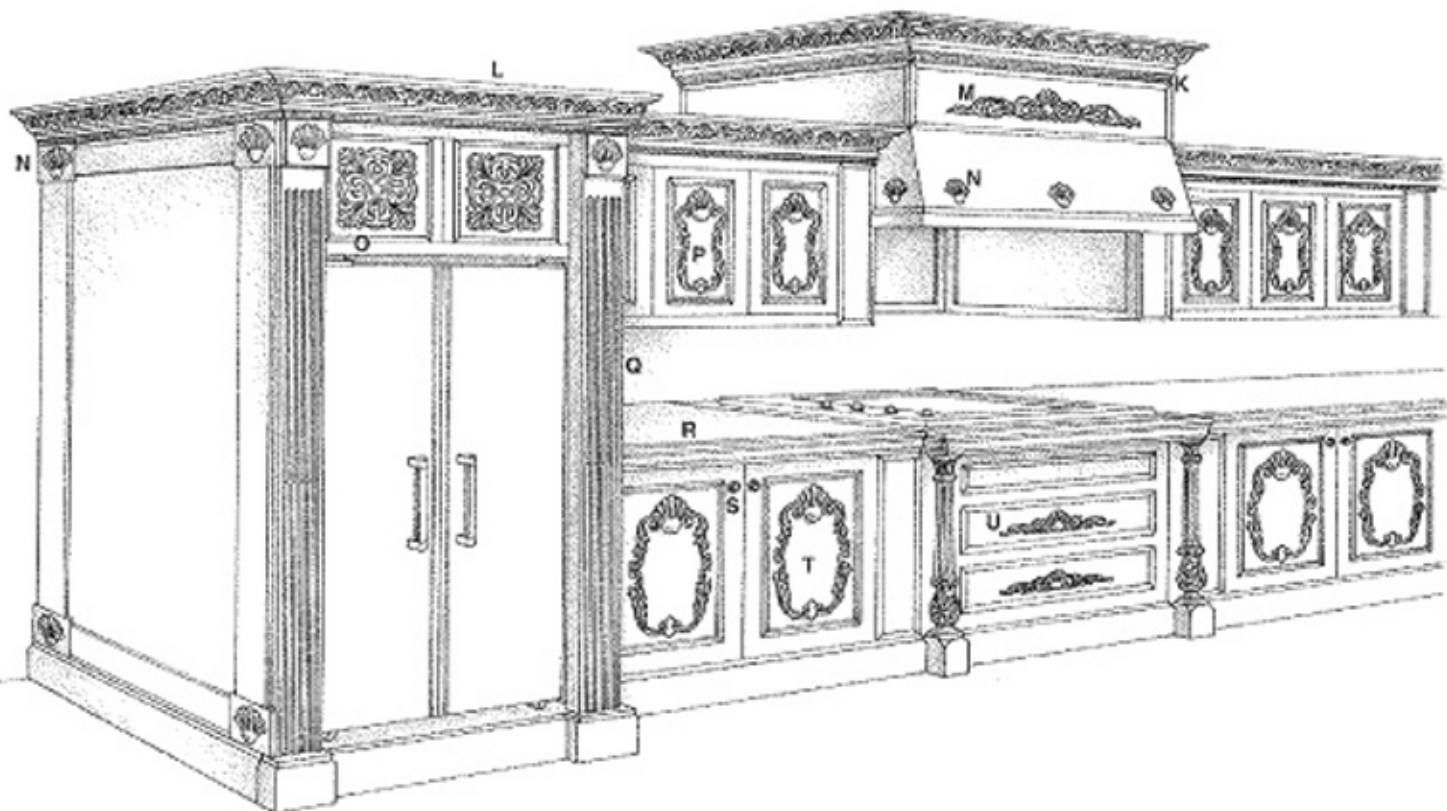

- L. MLD-AC9
- M. ONL-SH5
- N. ONL-SO1
- O. ROS-AS3
- P. PNL-SN2
- Q. CLM-FD3
- R. MLD-PO3
- S. PUL-SR0
- T. PNL-SW3
- U. PUL-SO3
- V. BLR-AF3

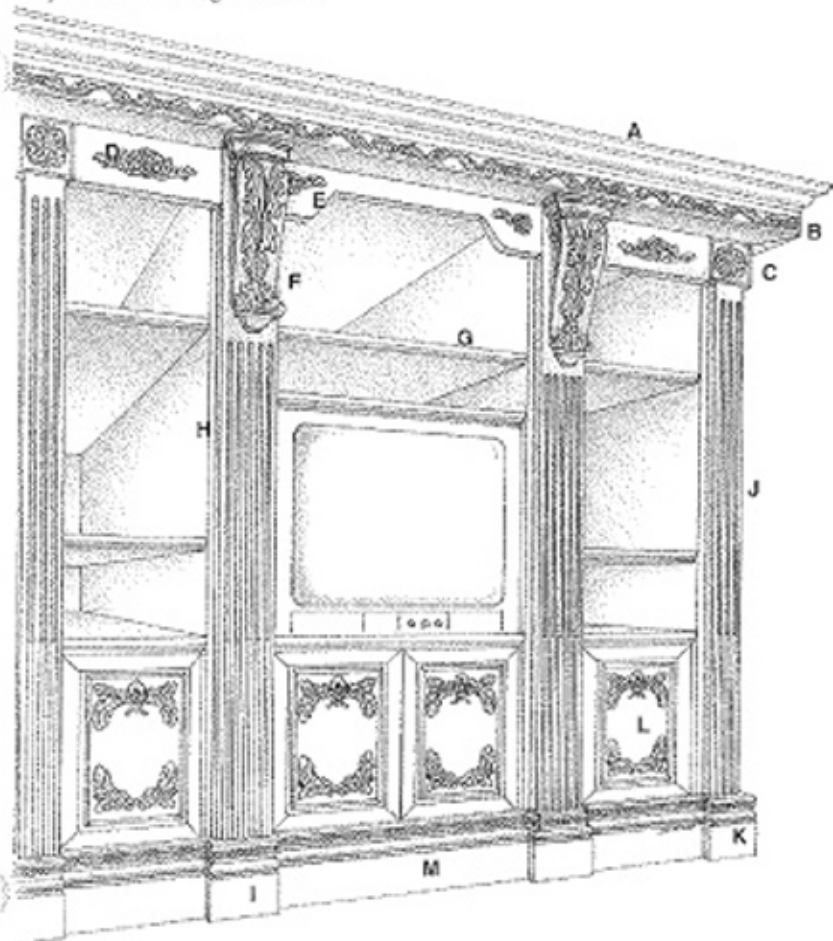

- A. MLD-PC9
- B. MLD-003
- C. ROS-AC2
- D. ONL-OH4
- E. ONL-OT1
- F. CBL-AP3
- G. MLD-PO2
- H. CLM-FD4
- I. CLM-PD4
- J. CLM-FP2
- K. CLM-PP2
- L. PNL-OM2
- M. MLD-LB3
- N. ROS-FC0
- O. PNL-FM2
- P. CLM-FP2
- Q. MLD-FA3
- R. MLD-PO2
- S. PNL-FM3
- T. PUL-FO1
- U. PNL-FW3
- V. CPL-CP3
- W. CLM-FD3
- X. CLM-PD3
- Y. MLD-LB3

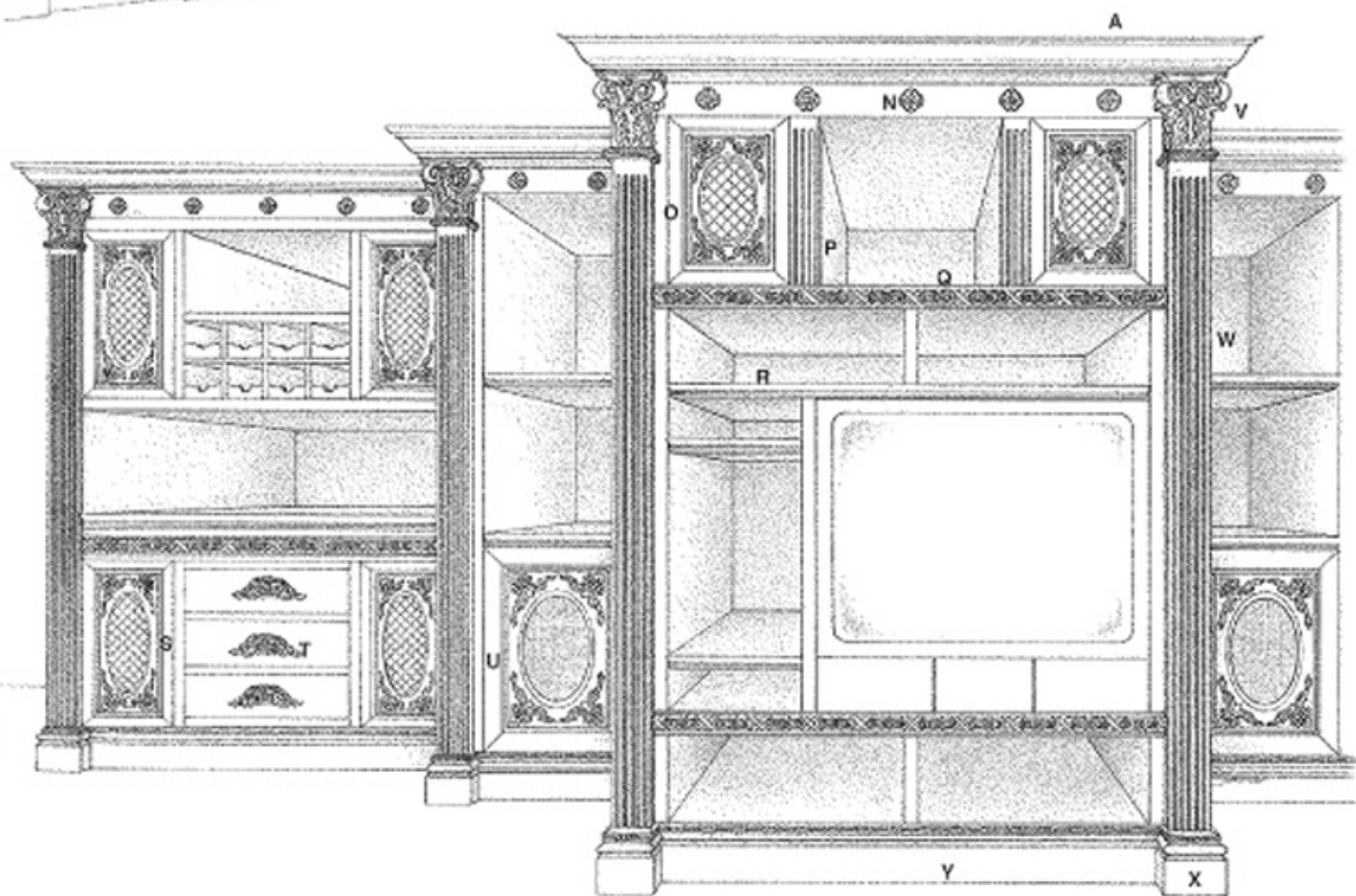

- A. CRW-F06
- B. MLD-LC5

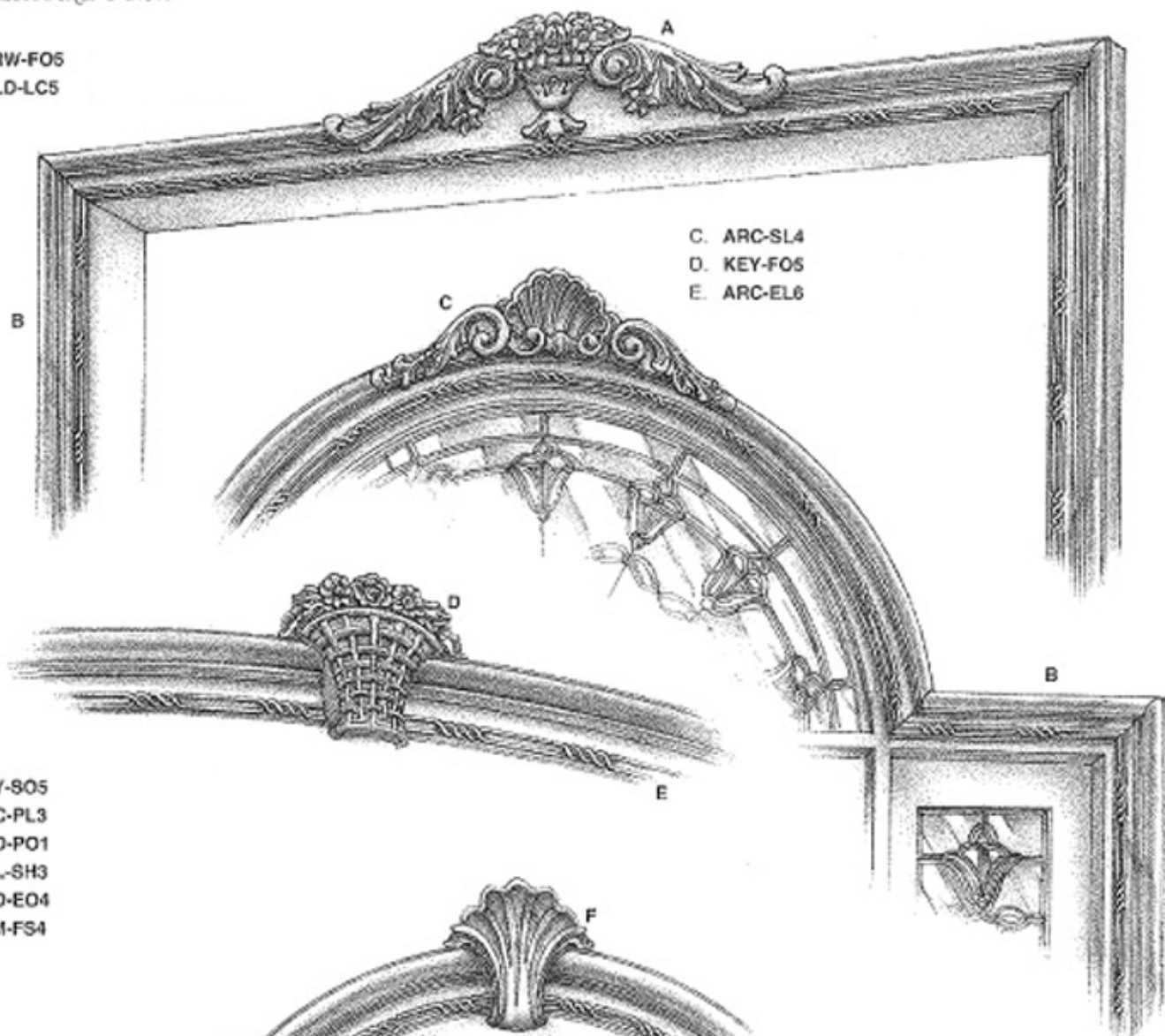

- C. ARC-SL4
- D. KEY-F06
- E. ARC-EL6

- F. KEY-S05
- G. ARC-PL3
- H. MLD-PO1
- I. ONL-SH3
- J. MLD-E04
- K. CLM-FS4

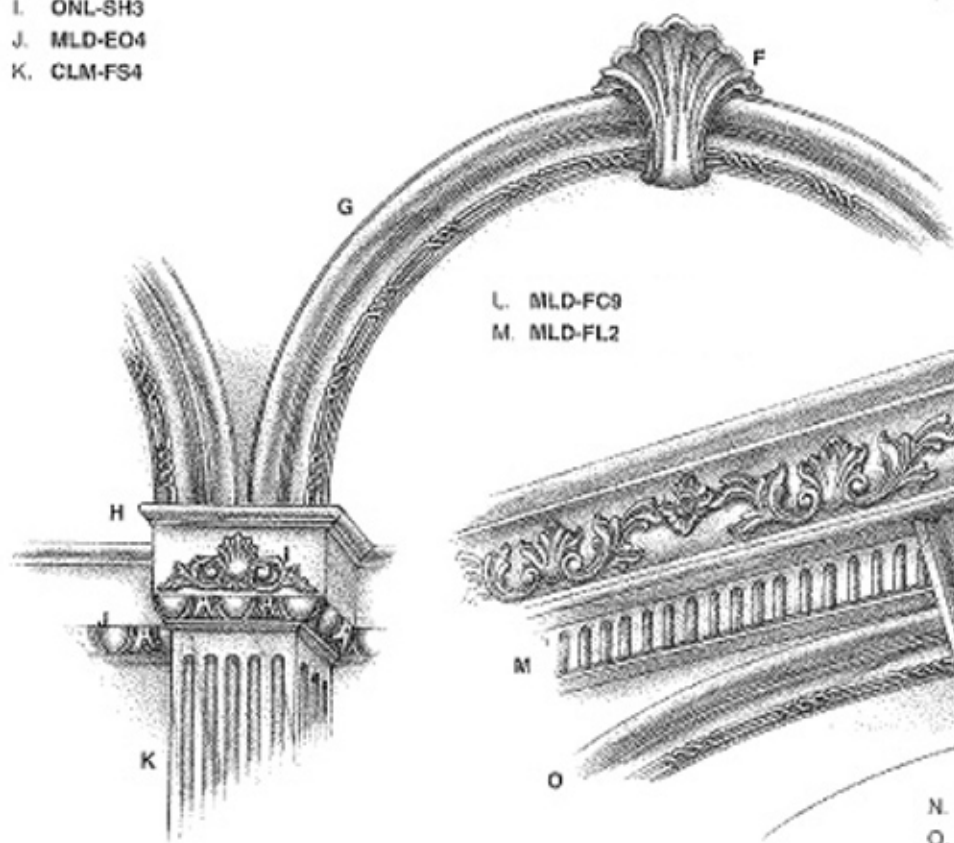

- L. MLD-FC9
- M. MLD-FL2

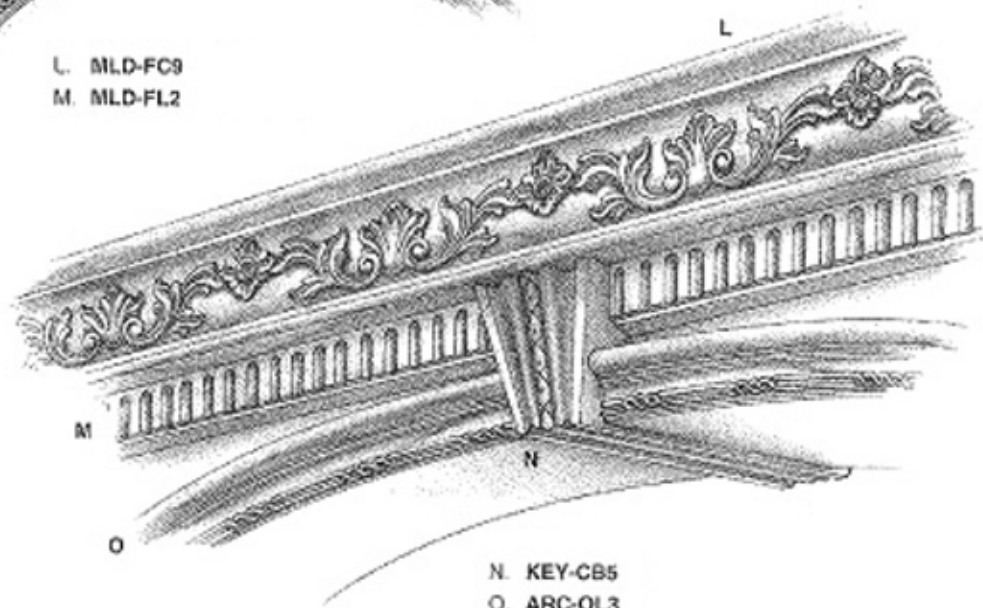

- N. KEY-CB5
- O. ARC-OL3

A. MLD-PT1
B. MLD-DO3
C. MLD-E03

D. CPL-IP4
E. CLM-FP4

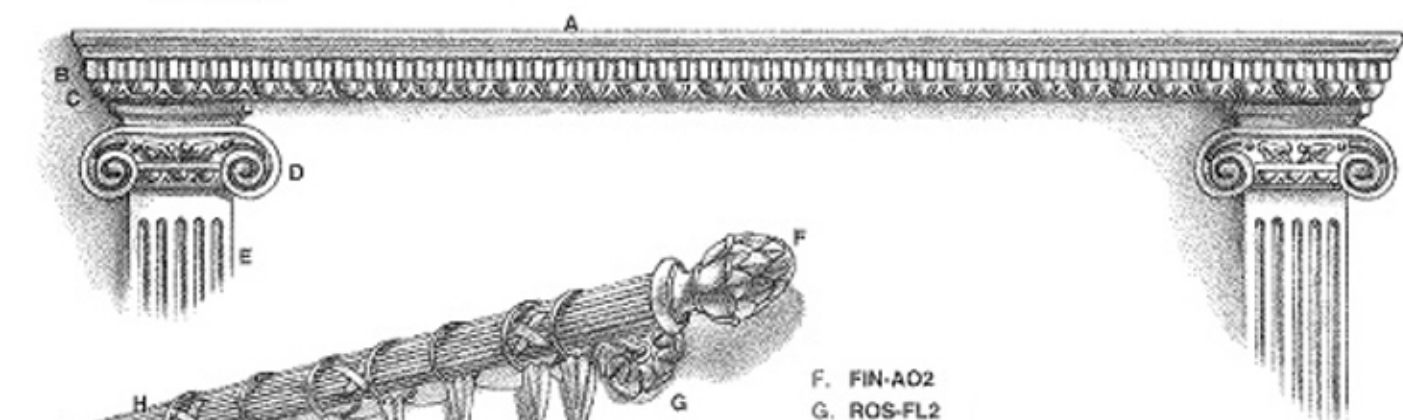

F. FIN-A02
G. ROS-FL2

H. MLD-RA3
I. CRW-SC3
J. MLD-LC3

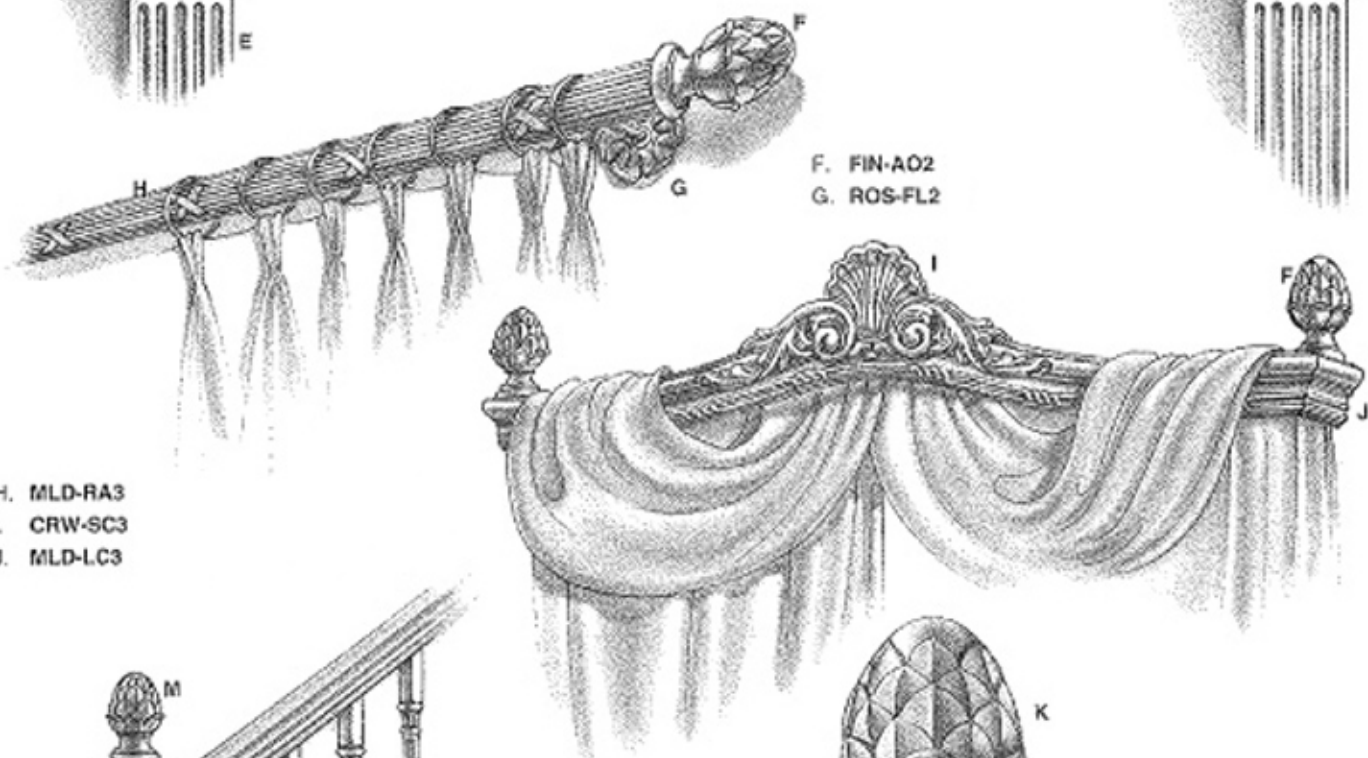

K. FIN-A04
L. MLD-PO3

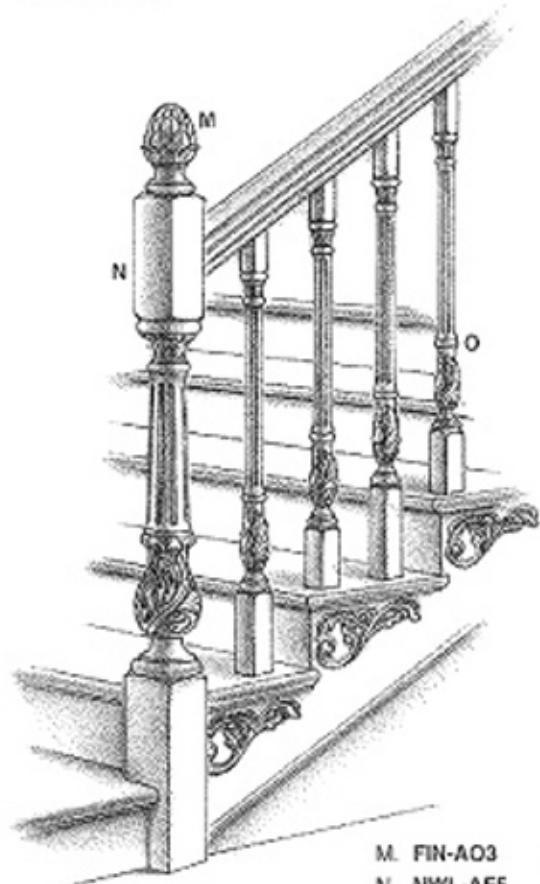

M. FIN-A03
N. NWL-AF5
O. BLR-AF2

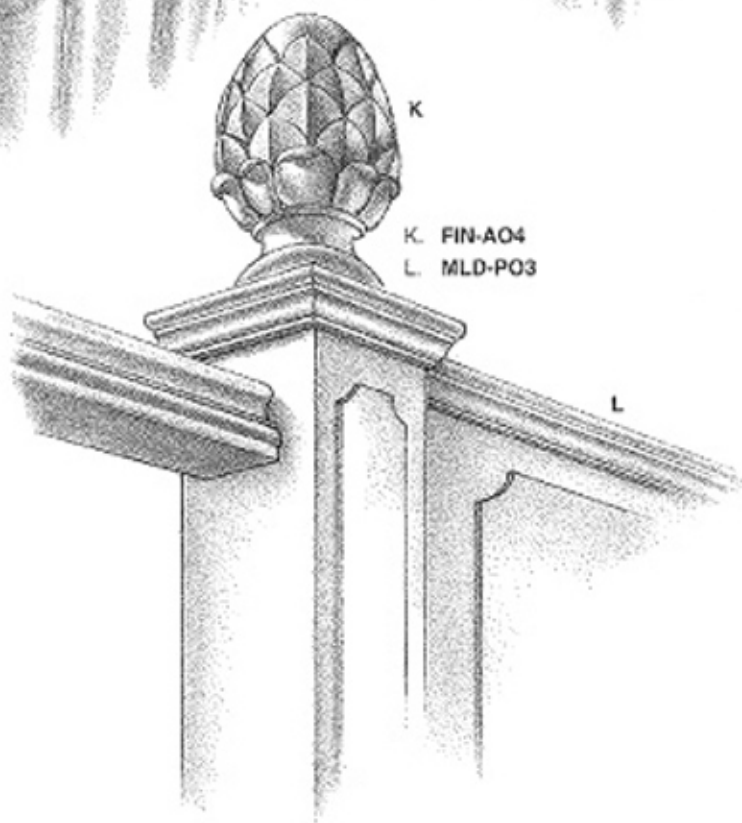

- A. MLD-PO3
- B. MLD-FO3
- C. ONL-FH5
- D. CBL-FO1
- E. CLM-FP3
- F. MLD-PO2
- G. ONL-FM3
- H. PNL-FM2
- I. MLD-PO3
- J. MLD-SP3
- K. ONL-HH4
- L. PNL-SM3
- M. CBL-TO1
- N. CLM-FD3
- O. MLD-PO2
- P. ONL-SM3
- Q. PNL-SM2
- R. PNL-SV/3
- S. PUL-SO1

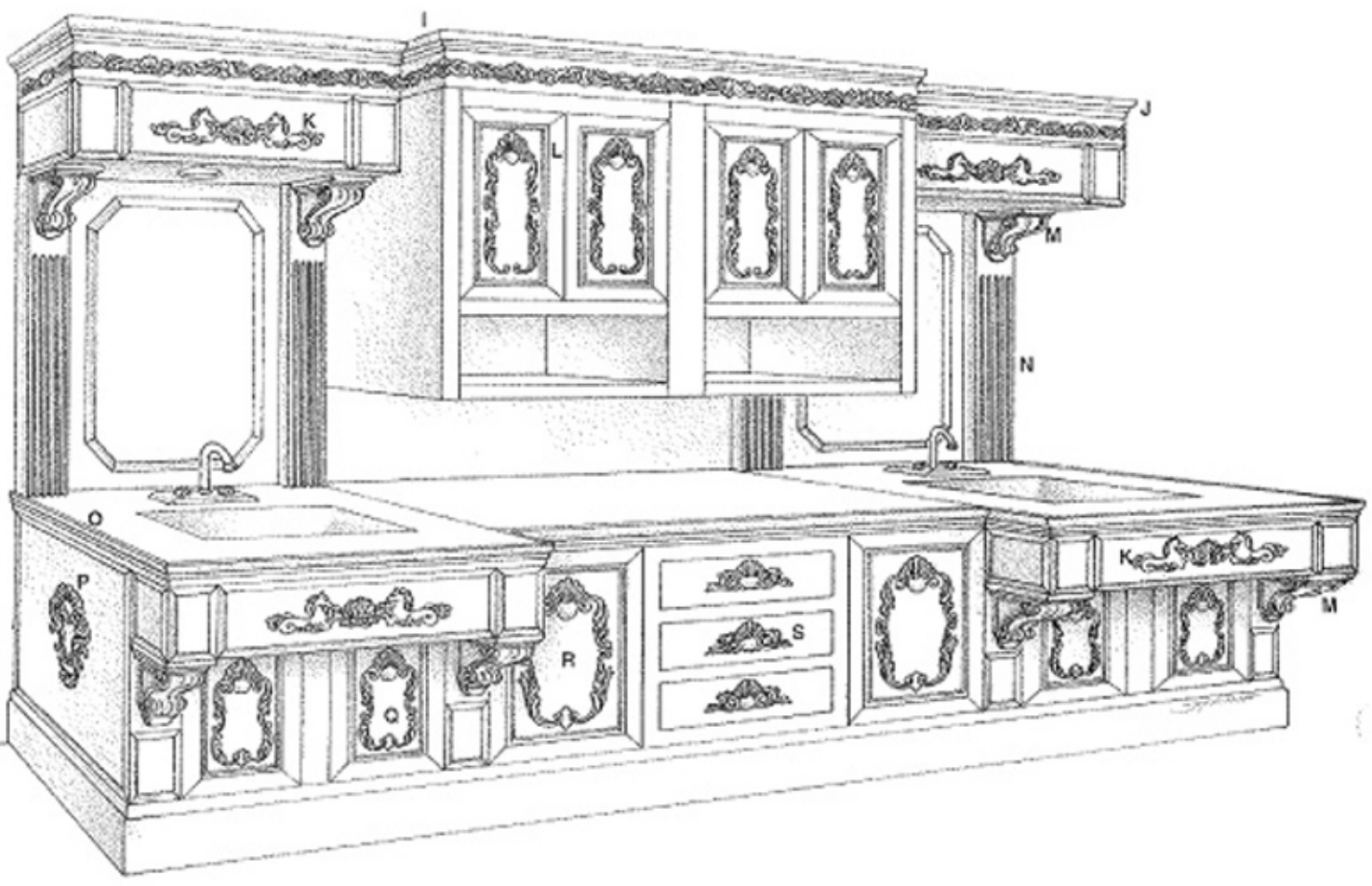
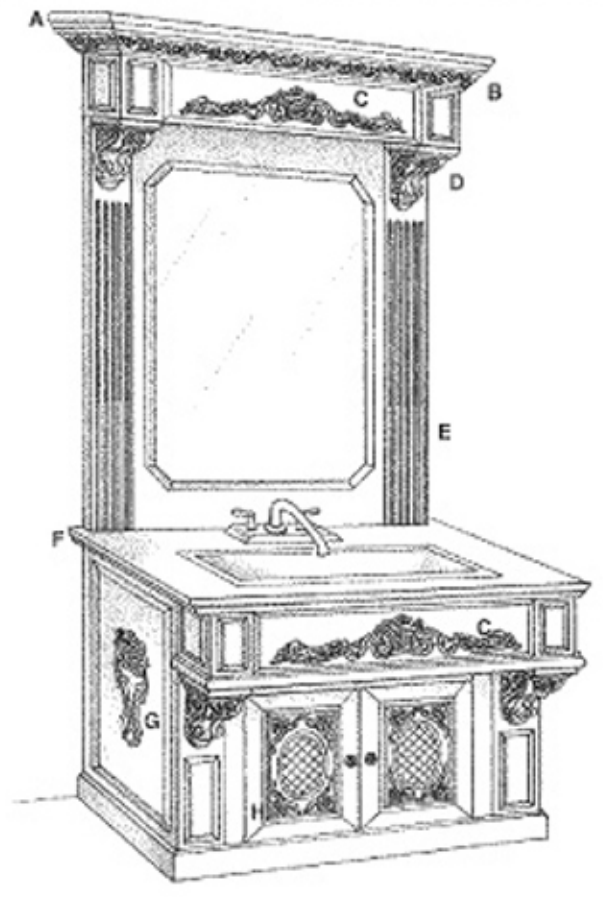

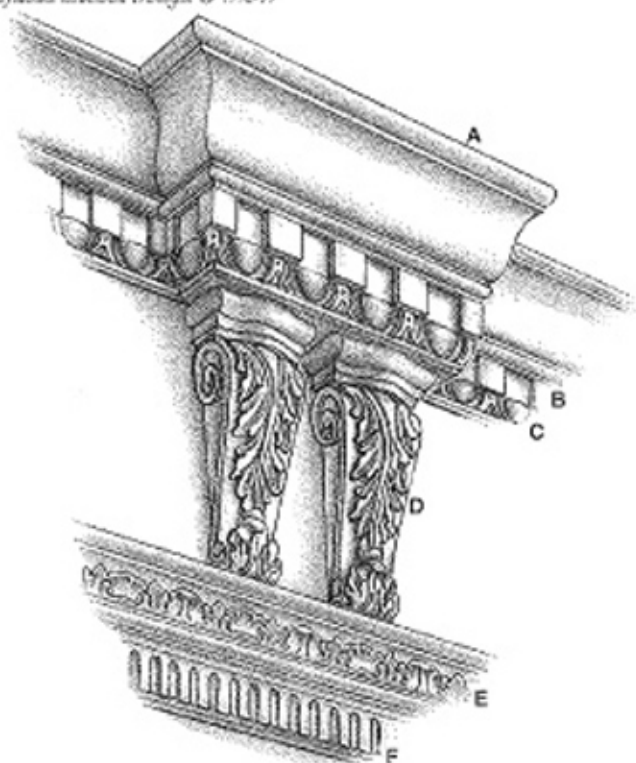

- A. MLD-PC9
- B. MLD-DO4
- C. MLD-EO4
- D. CBL-AP2
- E. MLD-AC6
- F. MLD-FL2

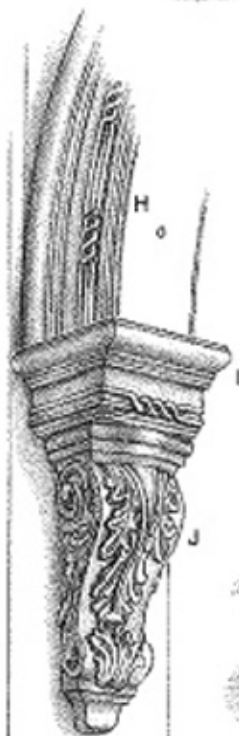
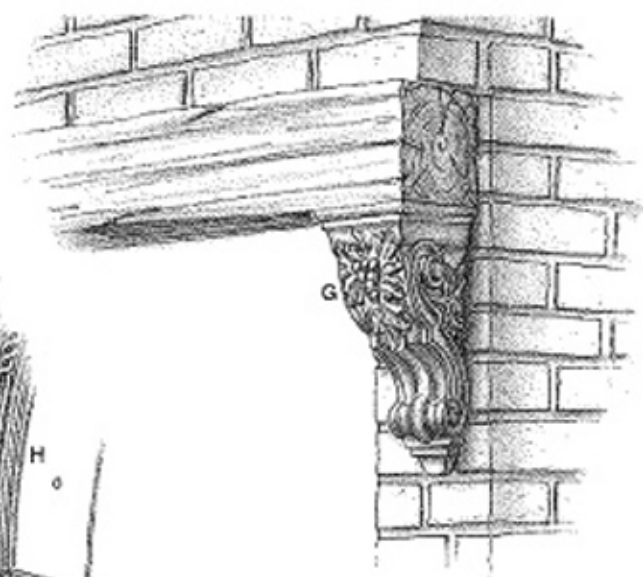

- H. ARC-PL4
- I. MLD-LC5
- J. CBL-AM1
- K. MLD-PC4
- L. CBL-AD3

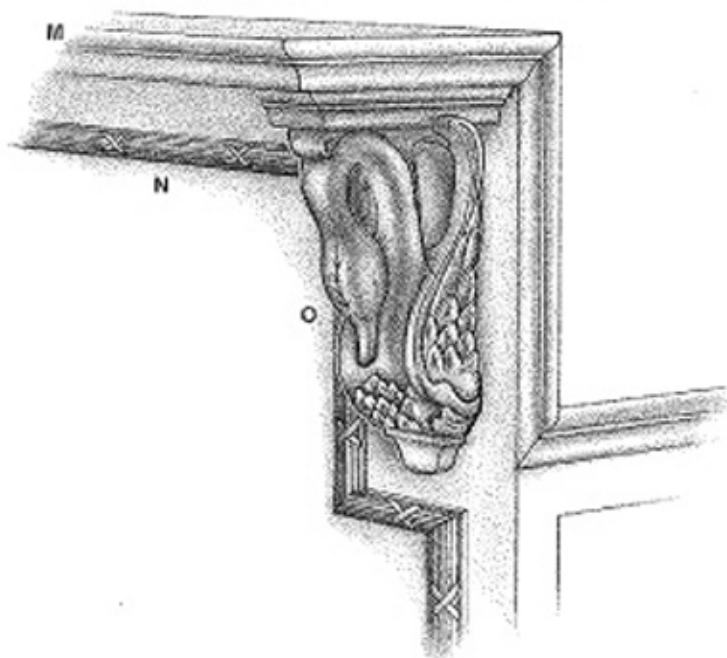

- M. MLD-PO3
- N. MLD-RA2
- O. CBL-SO2

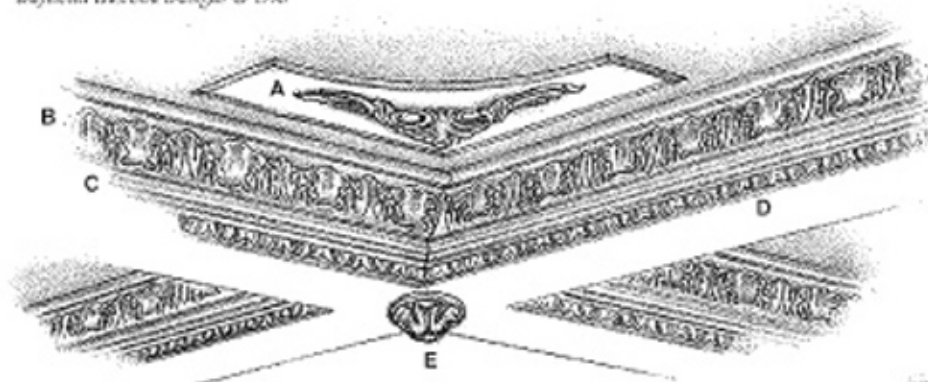

- A. ONL-AC3
- B. MLD-AC9
- C. MLD-PT1
- D. MLD-EO3
- E. ROS-FL2
- F. MLD-LC3
- G. MLD-PO1

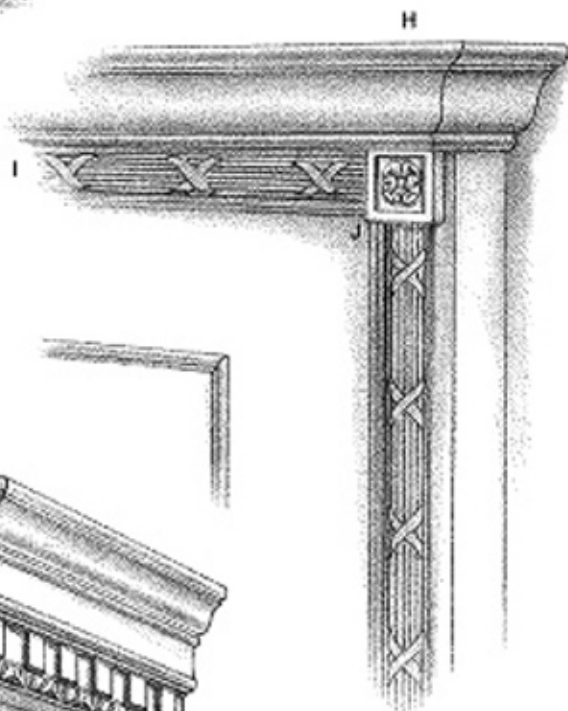
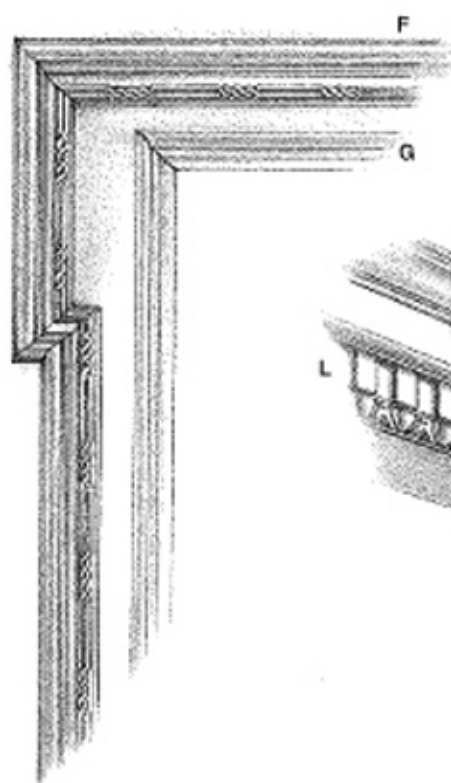

- H. MLD-PC6
- I. MLD-RA3
- J. ROS-FC0

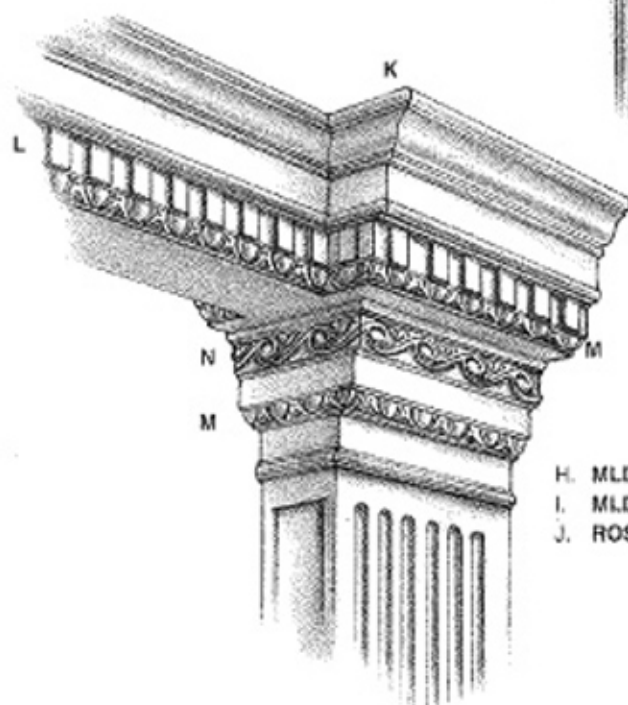

- K. MLD-PC8
- L. MLD-DO4
- M. MLD-EO4
- N. MLD-SW3

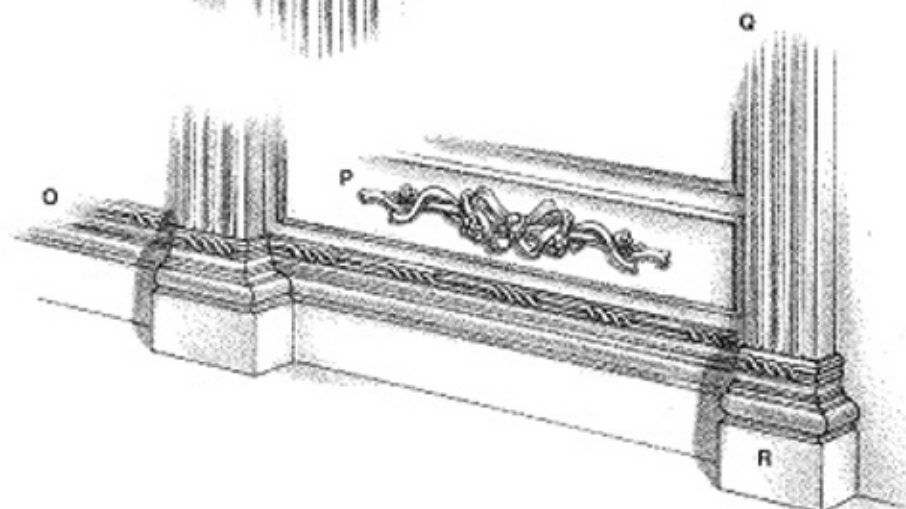

- O. MLD-LB3
- P. ONL-RH4
- Q. CLM-FP2
- R. CLM-PP2

Raymond Eitelbol Designs © 1996-99

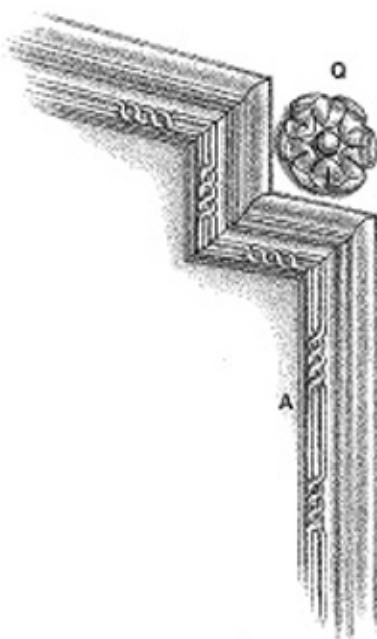
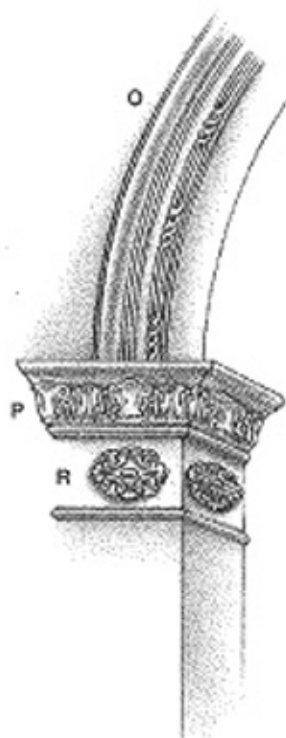
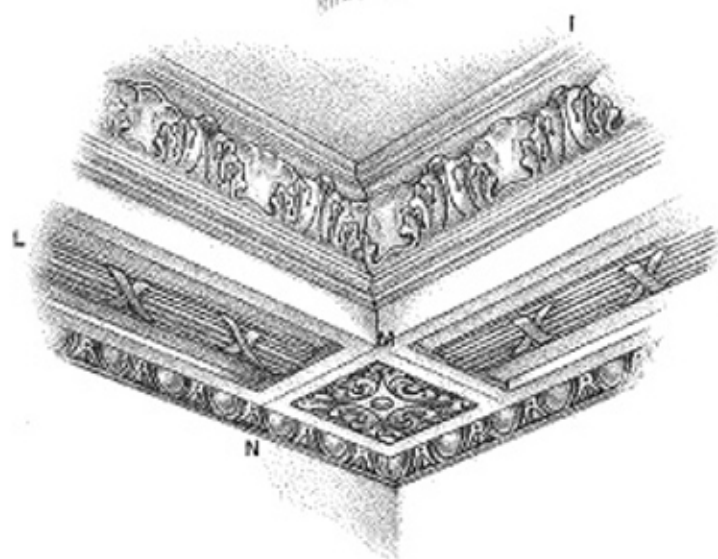
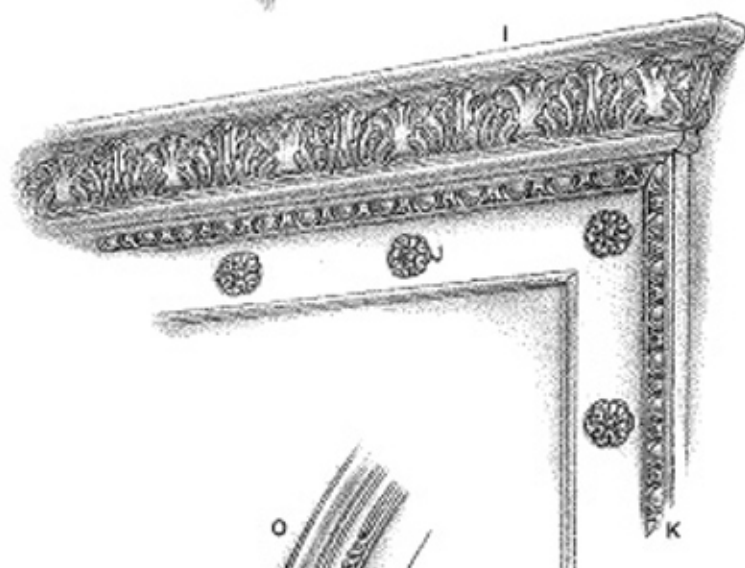
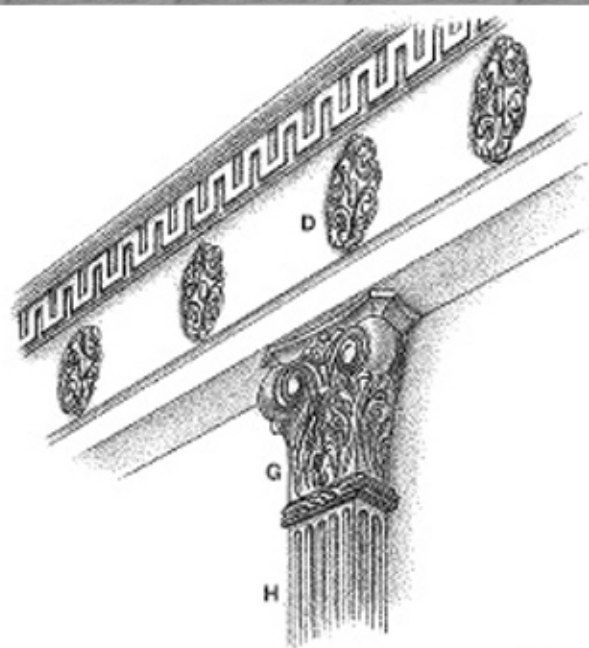
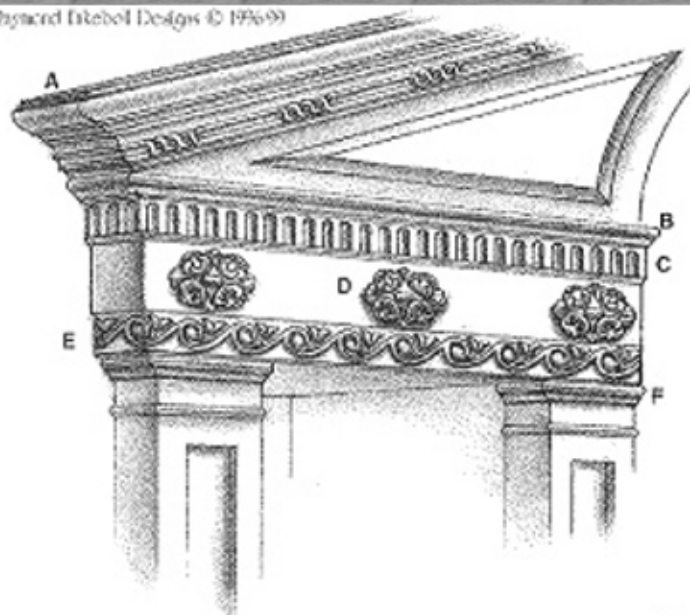

- A. MLD-LC5
- B. MLD-PT1
- C. MLD-FL2
- D. ROS-AO2
- E. MLD-SW3
- F. MLD-PO1
- G. CPL-CP4
- H. CLM-FD4
- I. MLD-AC9
- J. ROS-FC1
- K. MLD-EO3
- L. MLD-RA4
- M. ROS-AS3
- N. MLD-EO4
- O. ARC-PL4
- P. MLD-AC6
- Q. ROS-FC2
- R. ROS-AO2

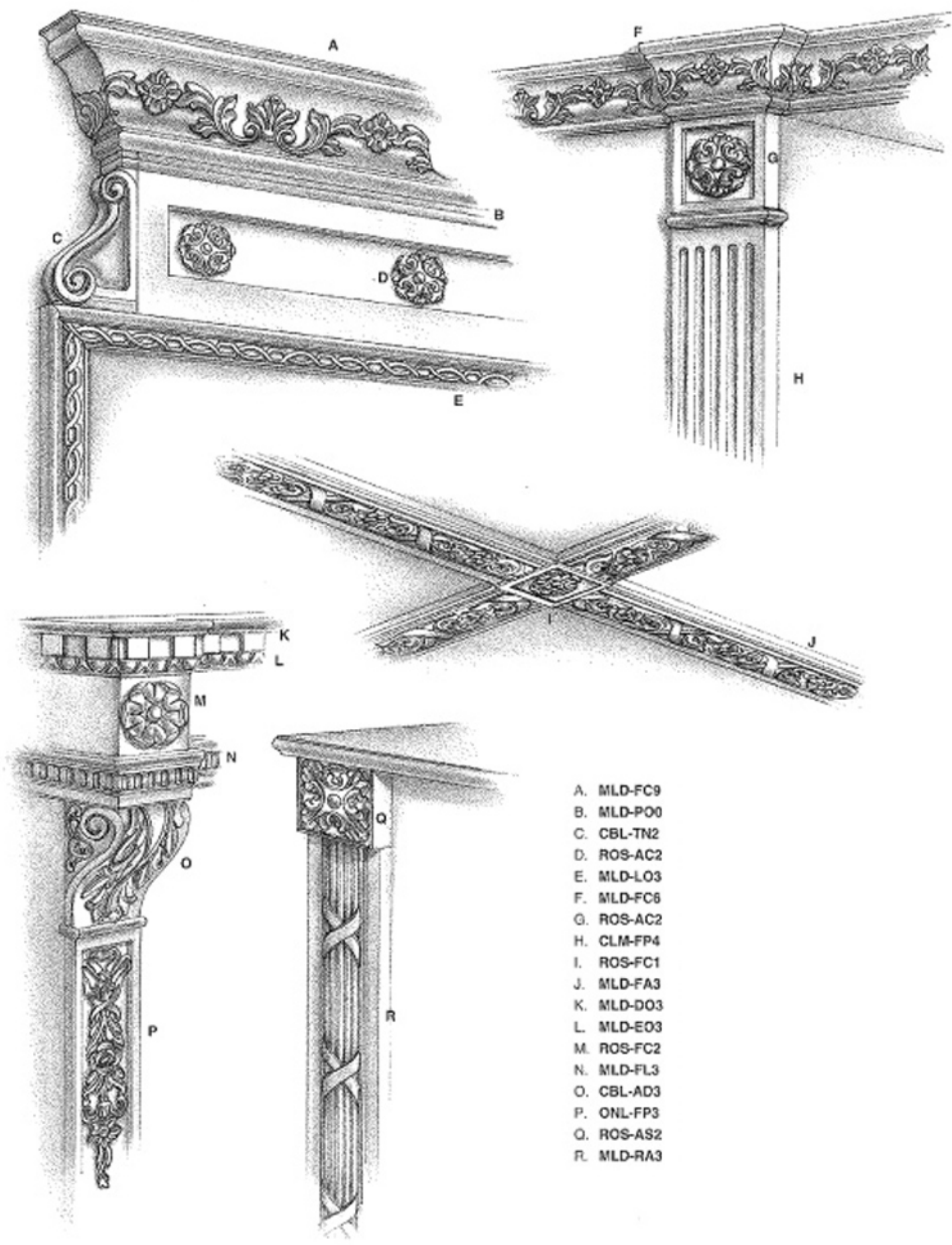

- A. MLD-FC9
- B. MLD-PO0
- C. CBL-TN2
- D. ROS-AC2
- E. MLD-LO3
- F. MLD-FC6
- G. ROS-AC2
- H. CLM-FP4
- I. ROS-FC1
- J. MLD-FA3
- K. MLD-DO3
- L. MLD-EO3
- M. ROS-FC2
- N. MLD-FL3
- O. CBL-AD3
- P. ONL-FP3
- Q. ROS-AS2
- R. MLD-RA3

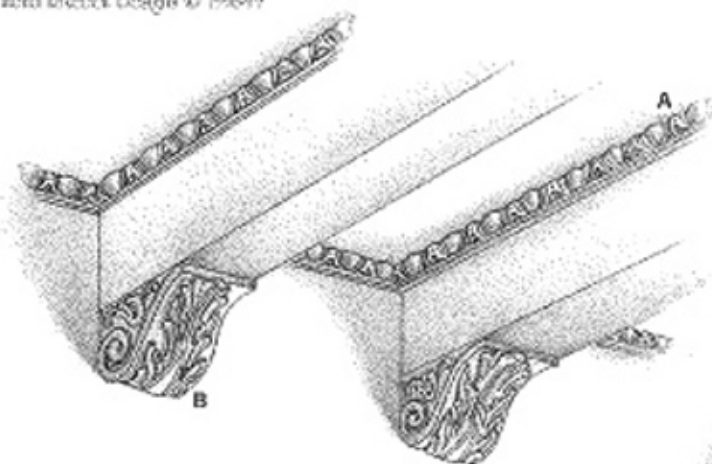

A. MLD-E04
 B. CBL-AD3

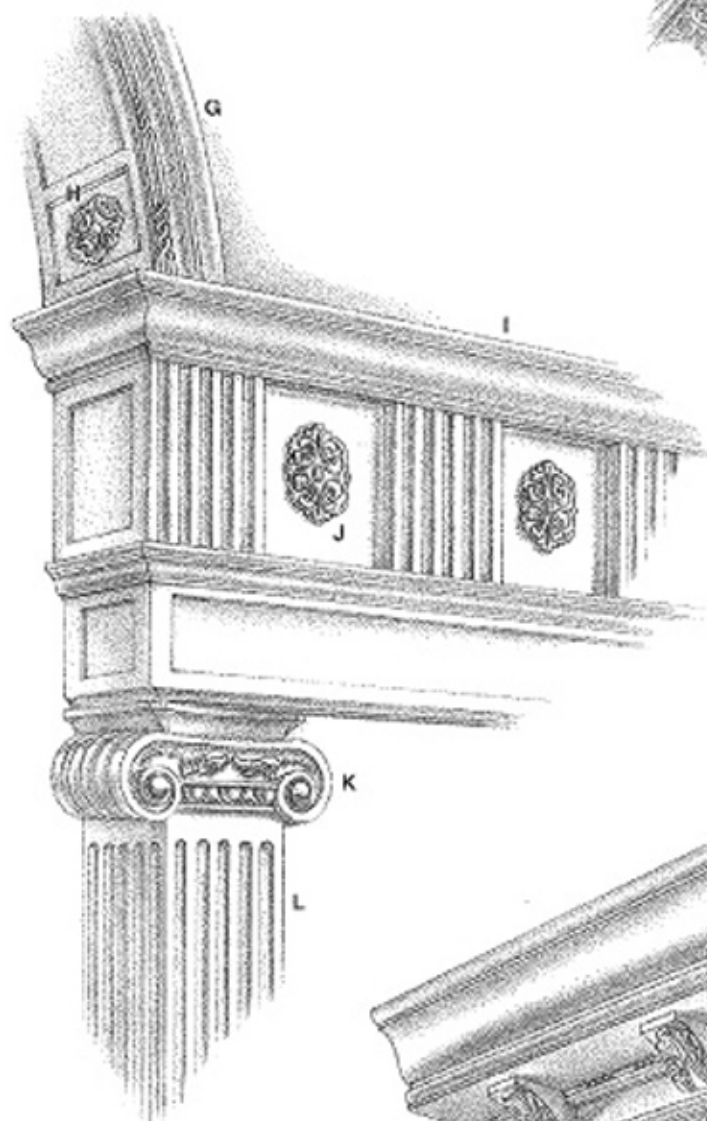
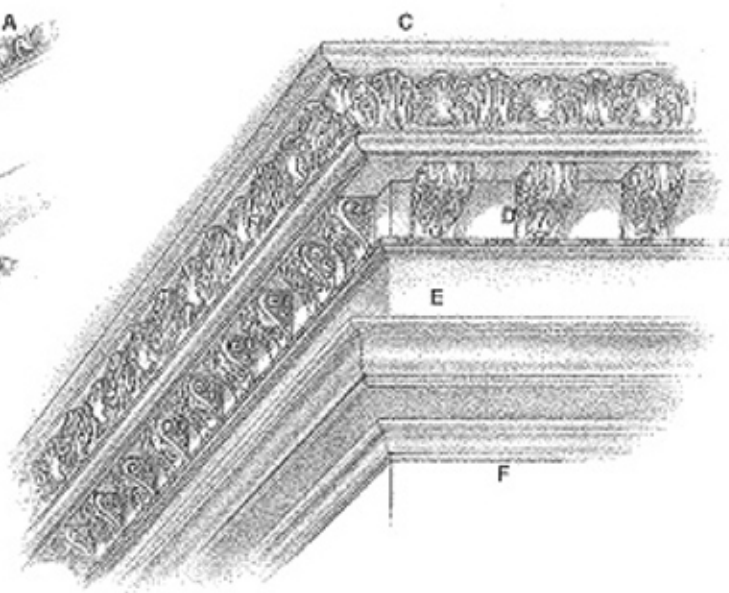

C. MLD-AC9
 D. CBL-AD1
 E. MLD-PC6
 F. MLD-PO3
 G. ARC-PL5
 H. ROS-AC2
 I. MLD-PC6
 J. ROS-AO2
 K. CPL-IO4
 L. CLM-FS4
 M. MLD-PC6
 N. MLD-BO2
 O. CBL-AD0
 P. MLD-AO3

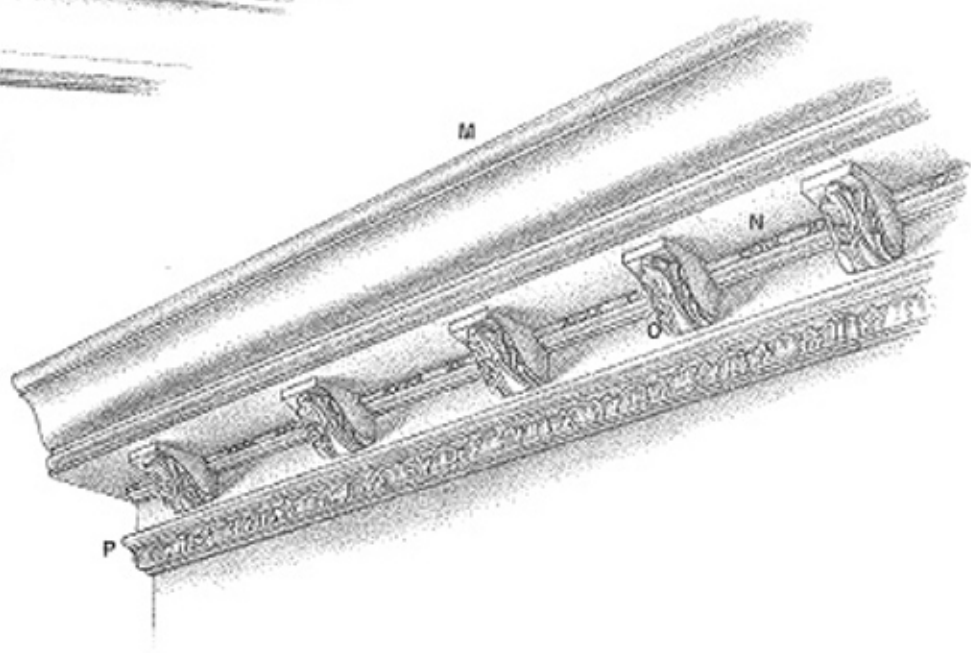

- A. MLD-OC6
- B. CBL-002
- C. CBL-FC9
- D. CBL-FO2
- E. MLD-PC6
- F. CBL-AB9
- G. MLD-AC6
- H. CBL-AB2

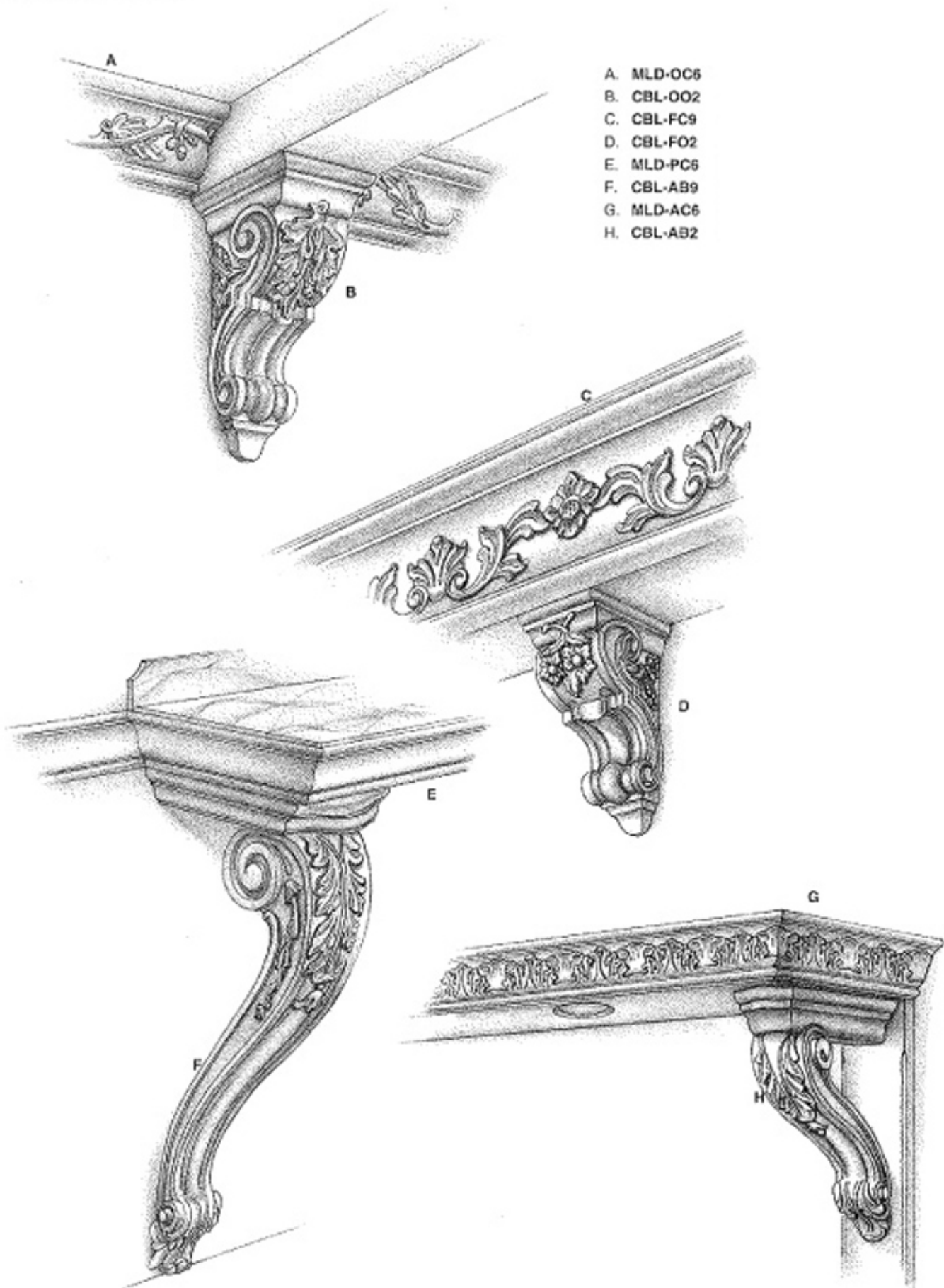

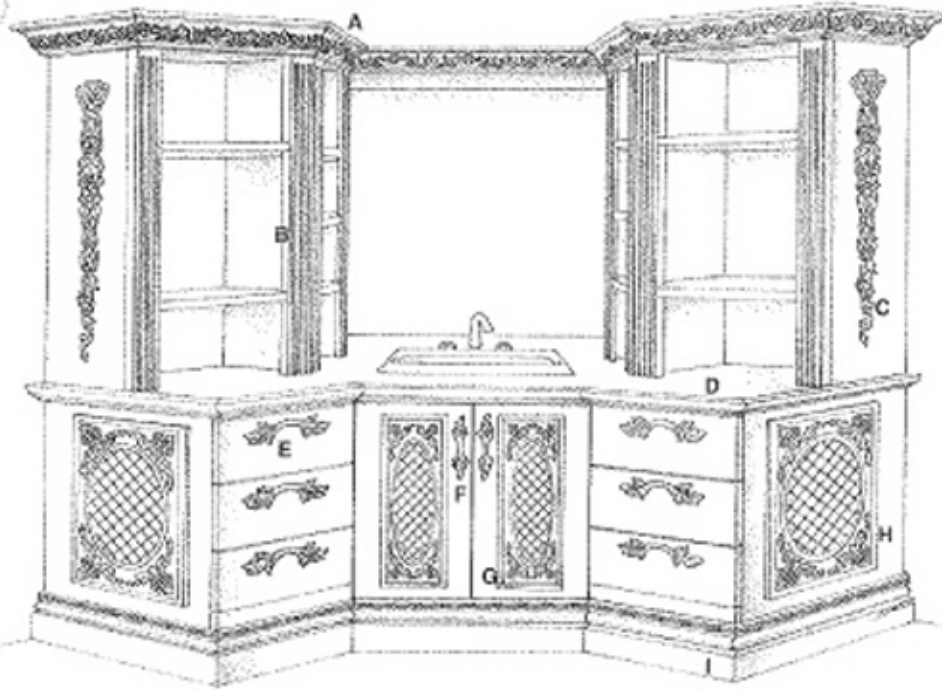

- A. MLD-FC9
- B. CLM-FP2
- C. ONL-FP5
- D. MLD-PO2
- E. PUL-LH1
- F. PUL-LV1
- G. PNL-FN3
- H. PNL-FW3
- I. MLD-LB3
- J. MLD-PC4
- K. MLD-SW5
- L. CPL-CR4
- M. CLM-AF4

- N. MLD-PO3
- O. MLD-MD3
- P. MLD-PO2
- Q. PUL-SO3
- R. PNL-SM2
- S. CBL-TO1
- T. MLD-PO0
- U. ONL-ND4
- V. ONL-NW3

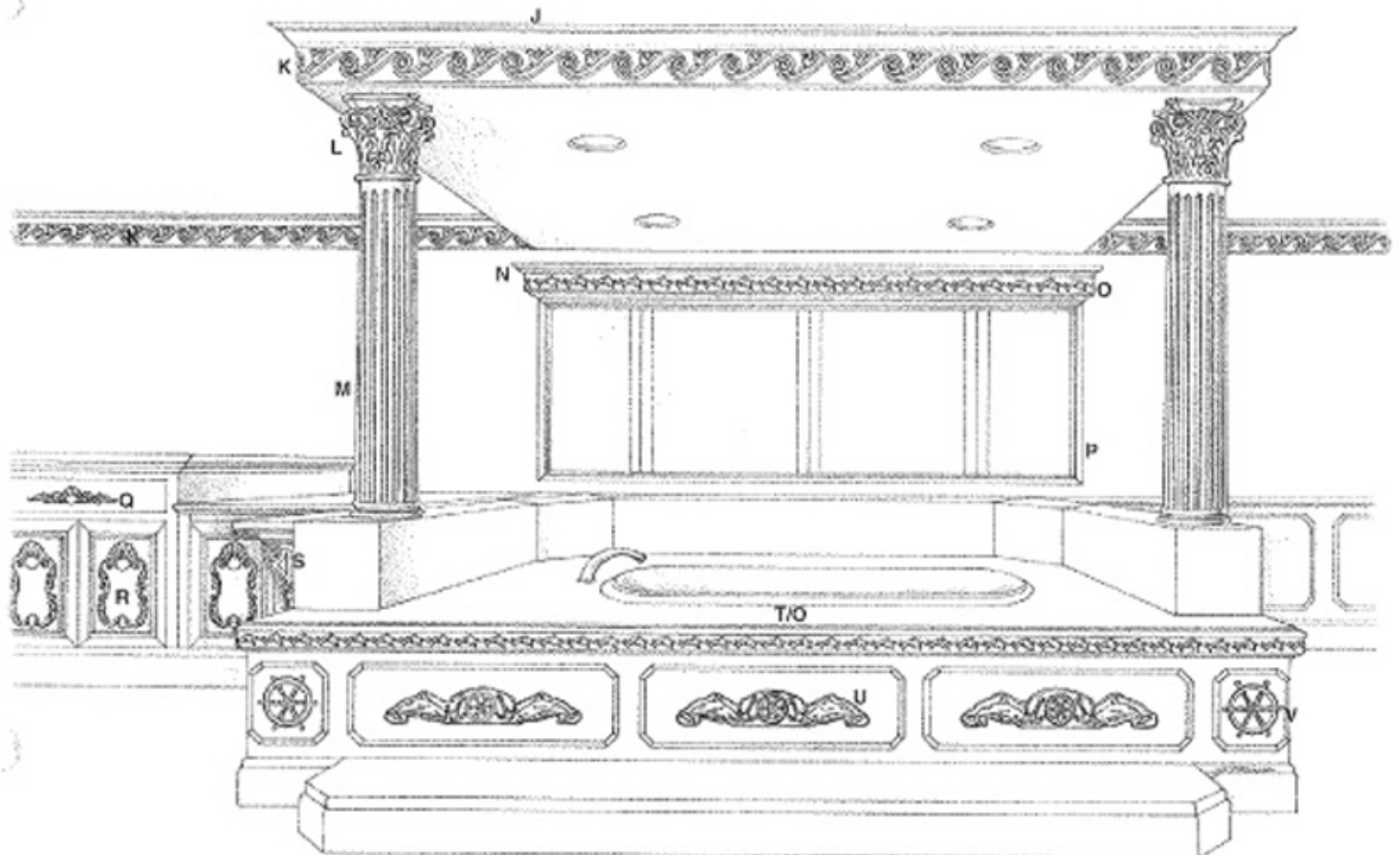

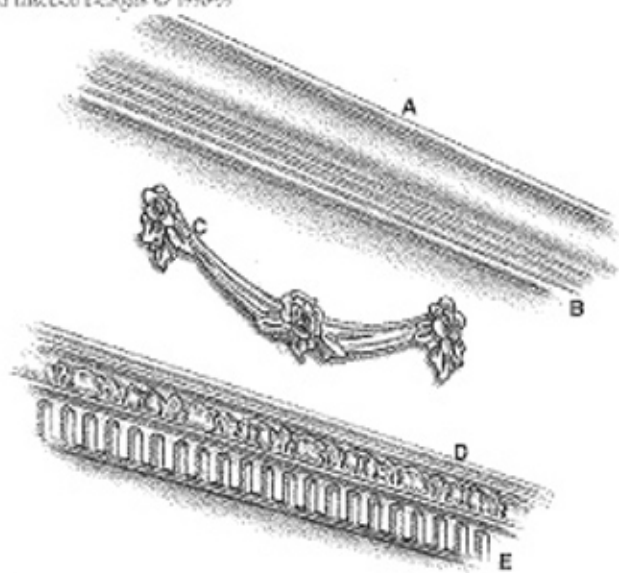

- A. MLD-PC9
- B. MLD-PO1
- C. ONL-FG5
- D. MLD-AC6
- E. MLD-FL2

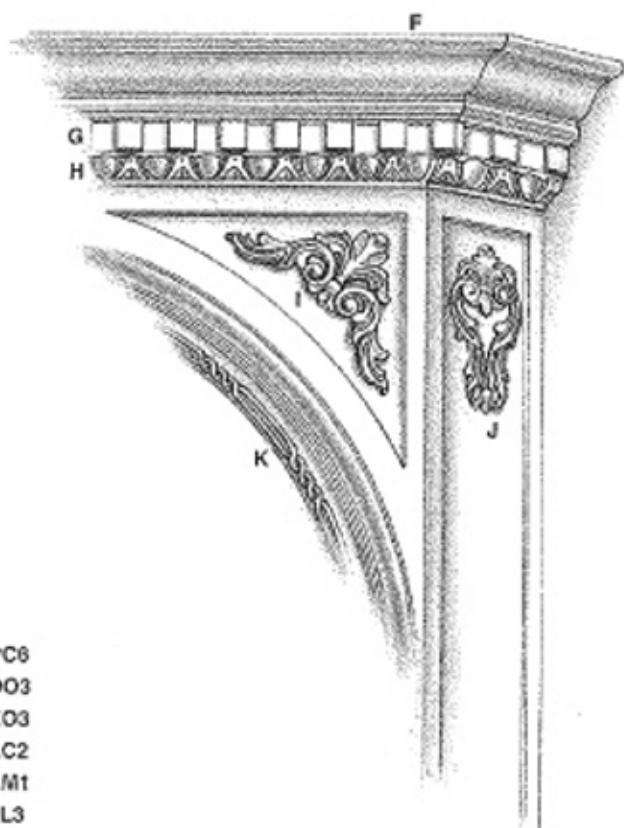

- F. MLD-PC6
- G. MLD-DO3
- H. MLD-EO3
- I. ONL-AC2
- J. ONL-AM1
- K. ARX-PL3

- L. ONL-FH4 Onlay Floral Horizontal X-Large
- M. ROS-FC0 Rosette Floral Circular Mini

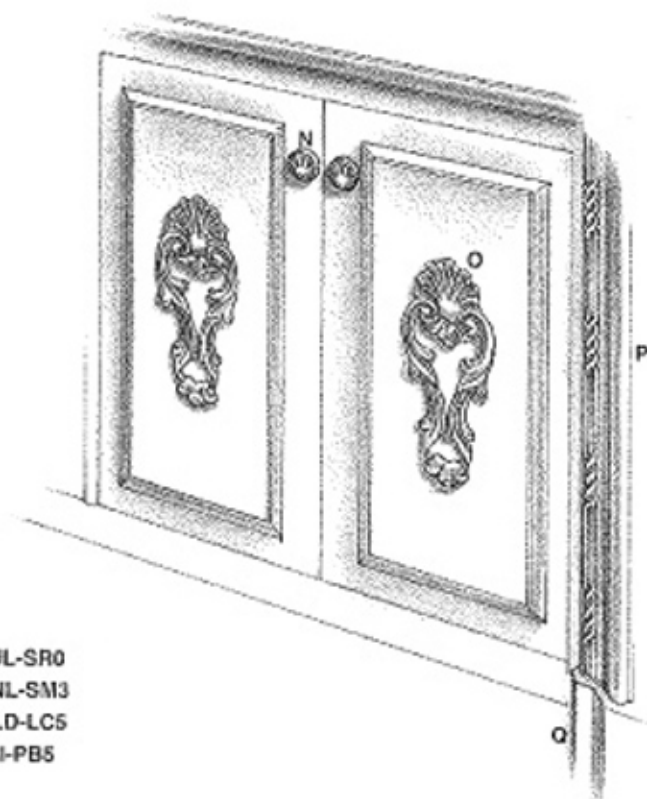
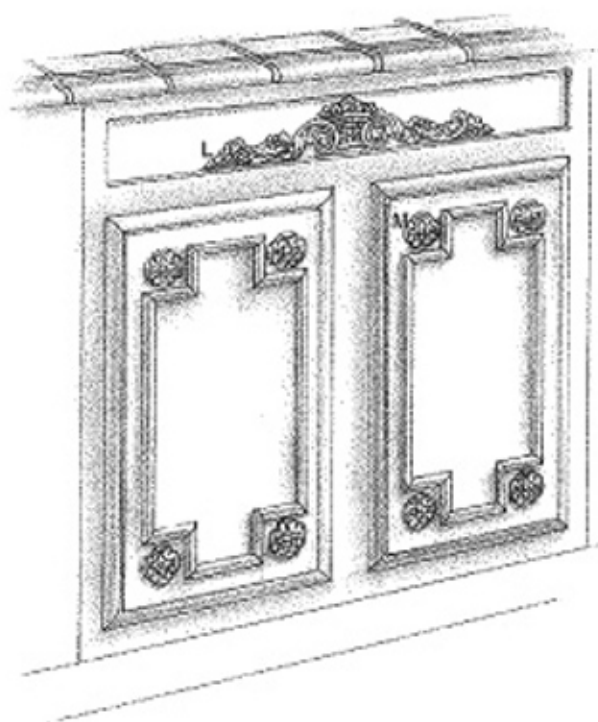

- N. PUL-SR0
- O. ONL-SM3
- P. MLD-LC5
- Q. PLI-PB5

- A. MLD-PC0
- B. MLD-SW3
- C. MLD-PC6
- D. ONL-NW1
- E. ONL-ND4
- F. MLD-SW5
- G. ONL-NB2
- H. ONL-NA2
- I. CLM-FP4
- J. CLM-PP4
- K. MLD-SW5
- L. MLD-RT2
- M. ONL-MD4
- N. MTL-TF8
- O. HED-BLK
- P. BAS-DO3
- Q. PLI-OO6
- R. MLD-PO3
- S. PNL-SW3
- T. MTL-ET8

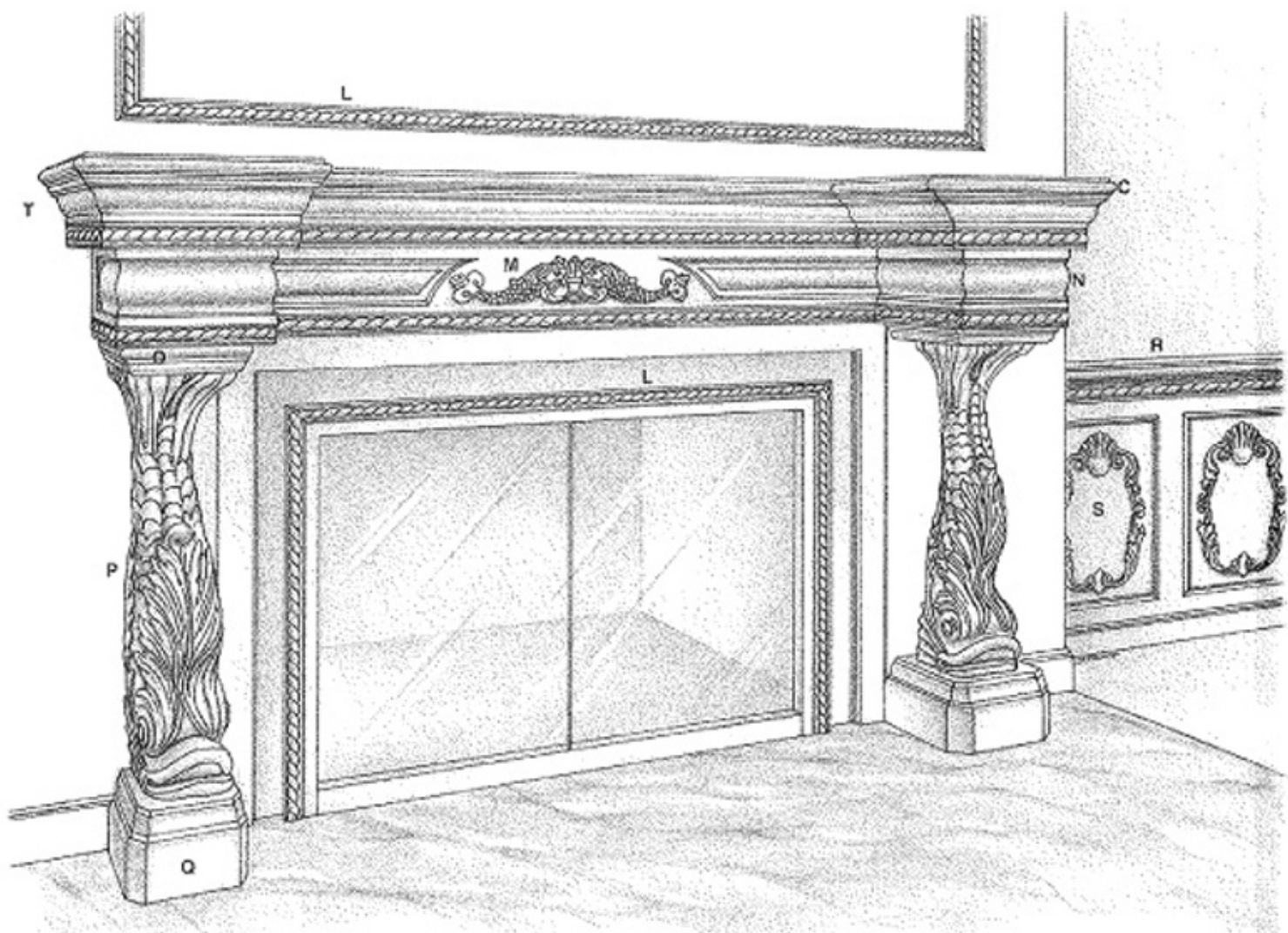
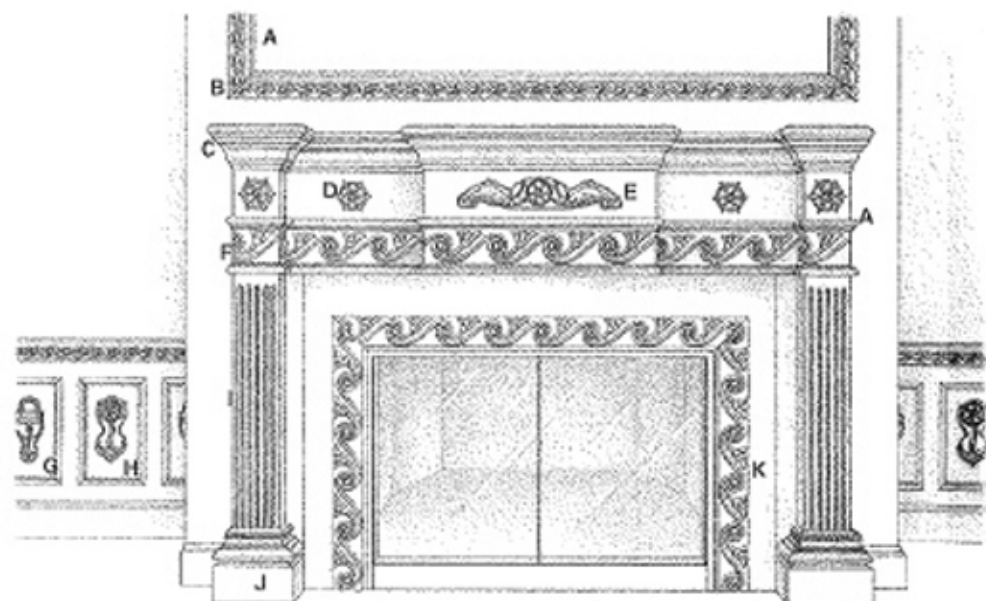

- A. BLR-TF2
- B. BLR-GF3
- C. MLD-PT1
- D. MLD-SW3
- E. NWL-G05
- F. BLR-G02
- G. BLR-P03

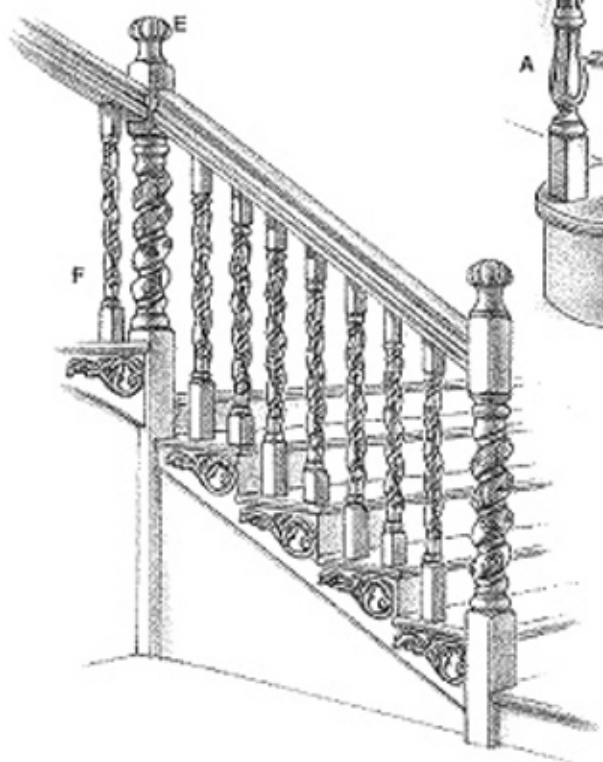
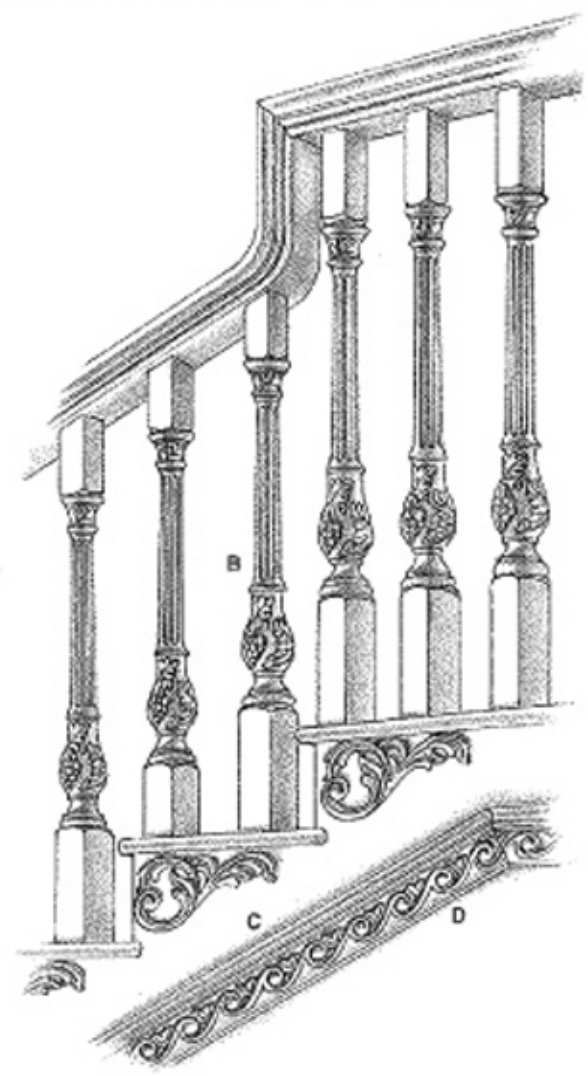
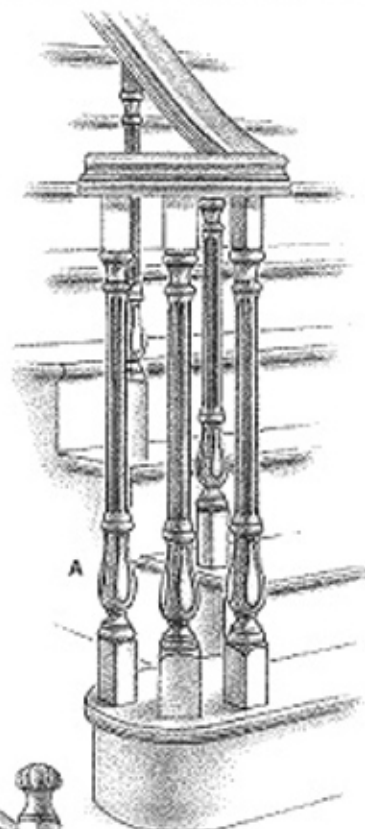

- H. NWL-AF5
- I. BLR-AF3
- J. MLD-OB6

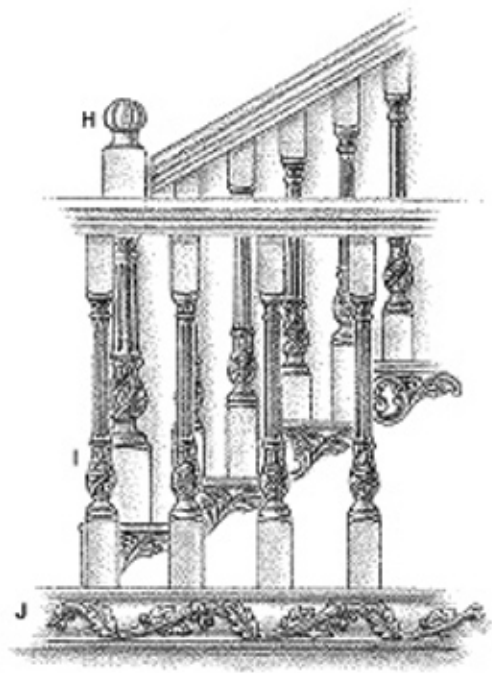
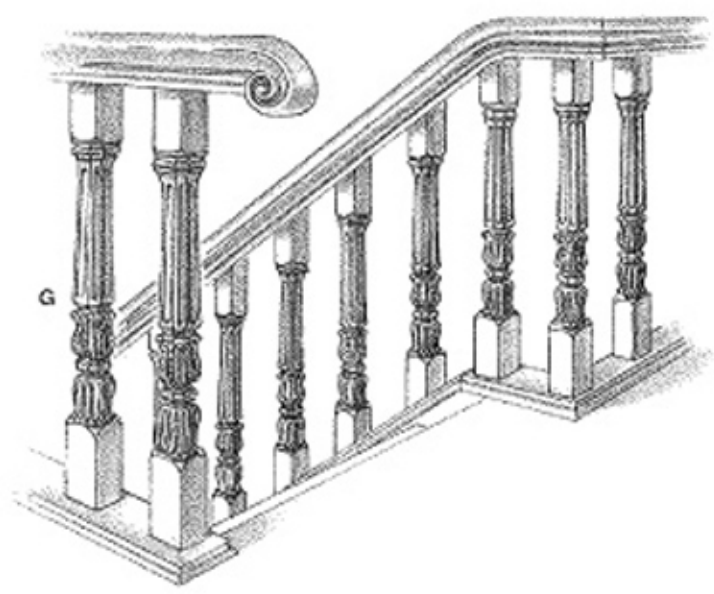

Dymond Eschhoff Designs © 1996-99

- A. MLD-AR5
- B. MLD-EA3
- C. HRL-FB1
- D. END-FO1
- E. MLD-LC5
- F. MLD-LB3
- G. BLR-TF3

- H. NWL-TF3
- I. OVE-FO1
- J. BLR-AP3
- K. BLR-AP2
- L. VOL-FR1
- M. BLR-GP3

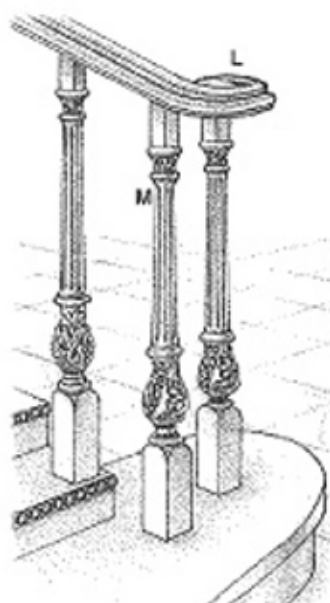
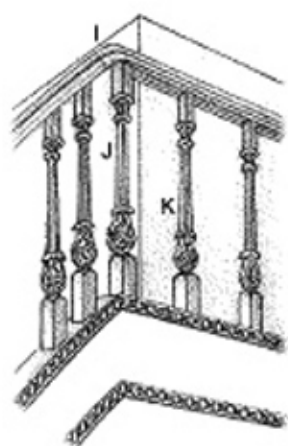
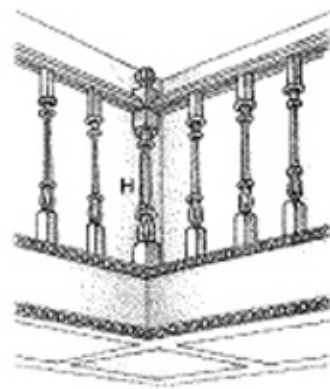
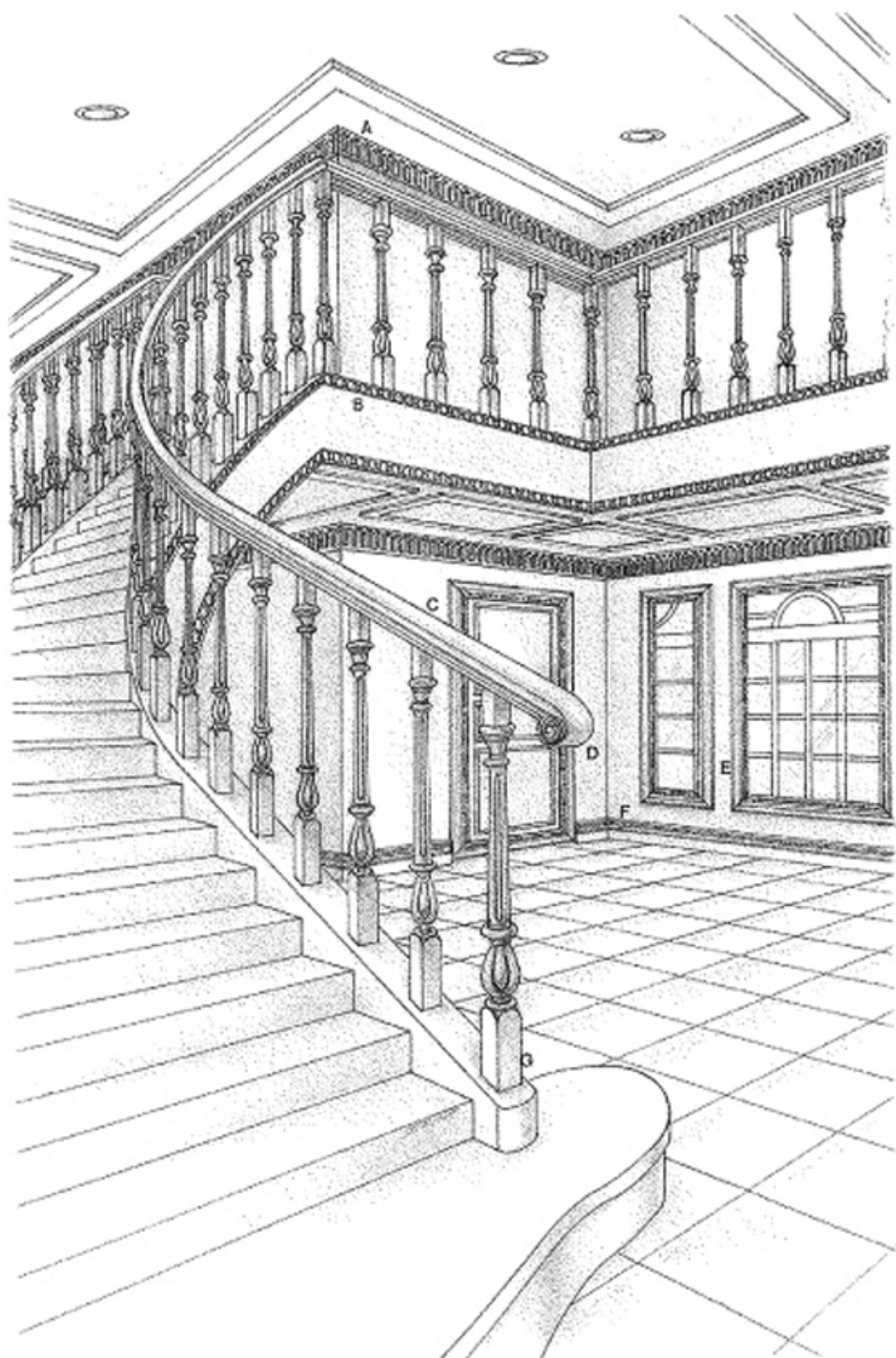

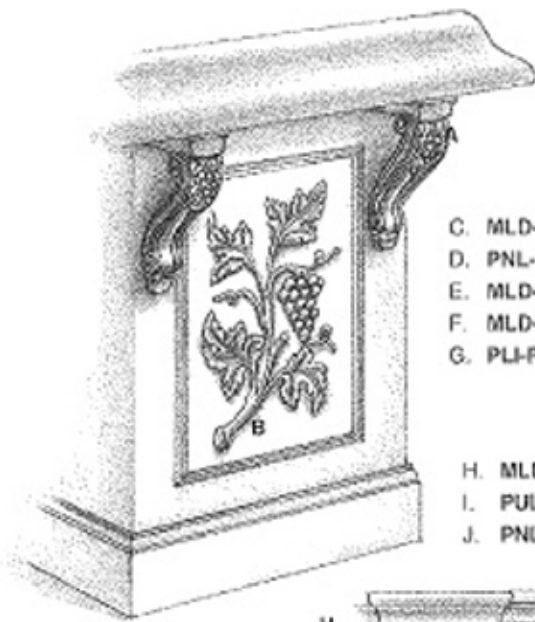

- A. CBL-GB2
- B. PNL-GW3

- C. MLD-FB6
- D. PNL-FM2
- E. MLD-LC3
- F. MLD-LB3
- G. PLI-PB3

- H. MLD-PO3
- I. PUL-GR0
- J. PNL-ON2

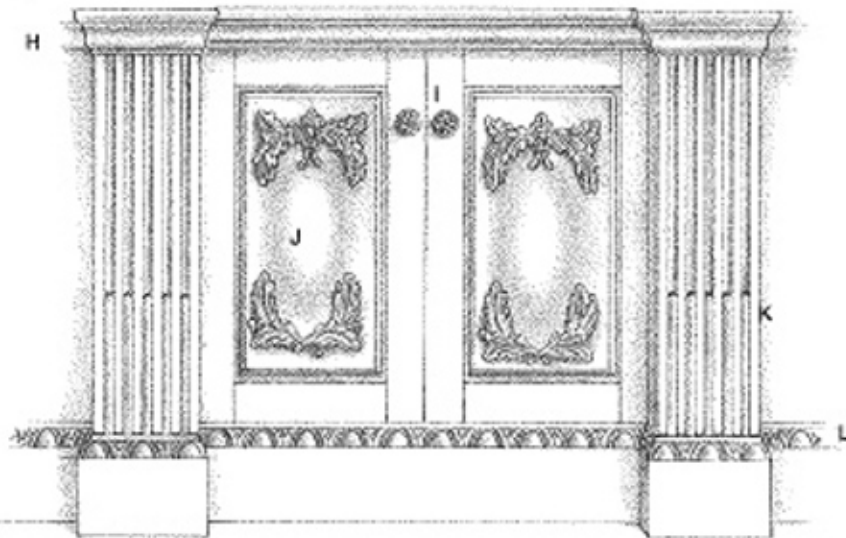
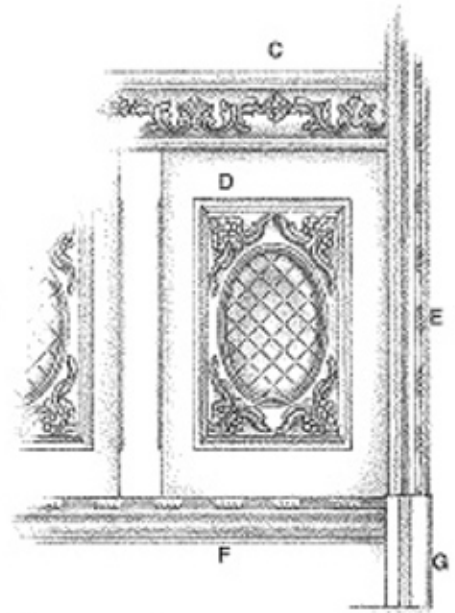

- K. CLM-FP4
- L. MLD-E04

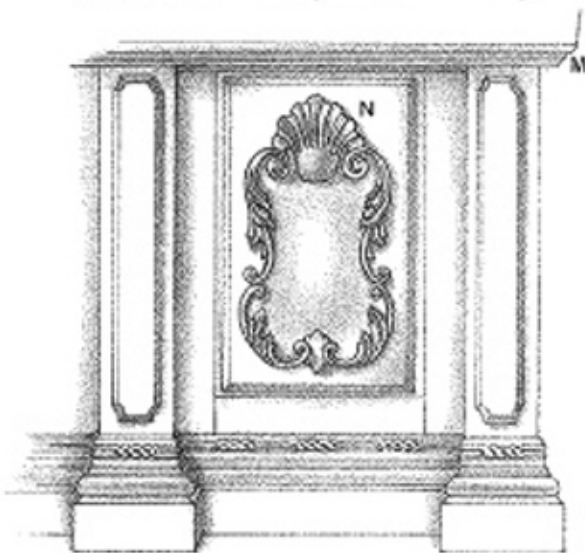

- M. MLD-BP2
- N. PNL-SW3

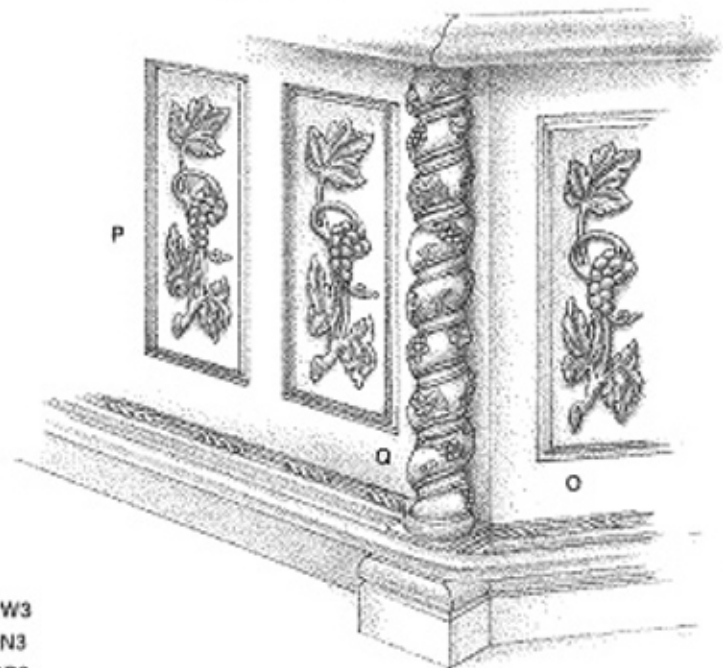

- O. PNL-GW3
- P. PNL-GN3
- Q. BAR-GP6

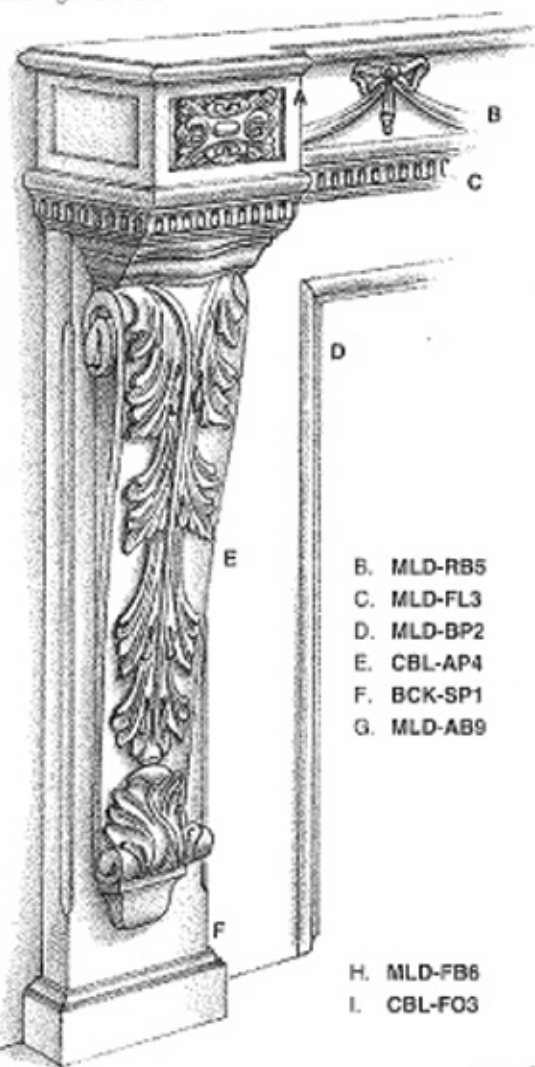

A. ROS-AR1

- B. MLD-RB5
- C. MLD-FL3
- D. MLD-BP2
- E. CBL-AP4
- F. BCK-SP1
- G. MLD-AB9



- H. MLD-FB6
- I. CBL-FO3

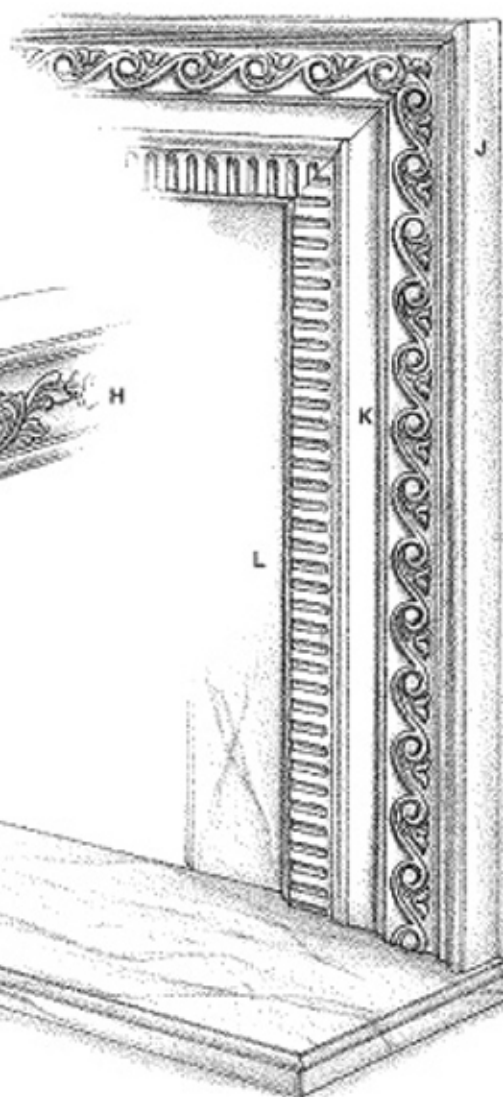

- J. MLD-SW3
- K. MLD-PO1
- L. MLD-FL2

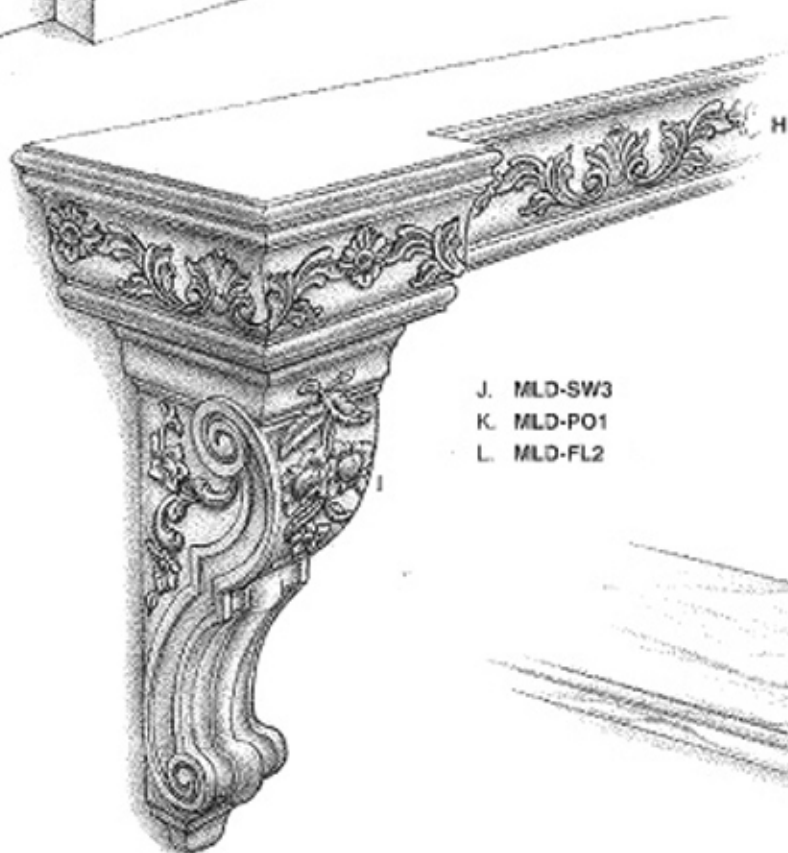

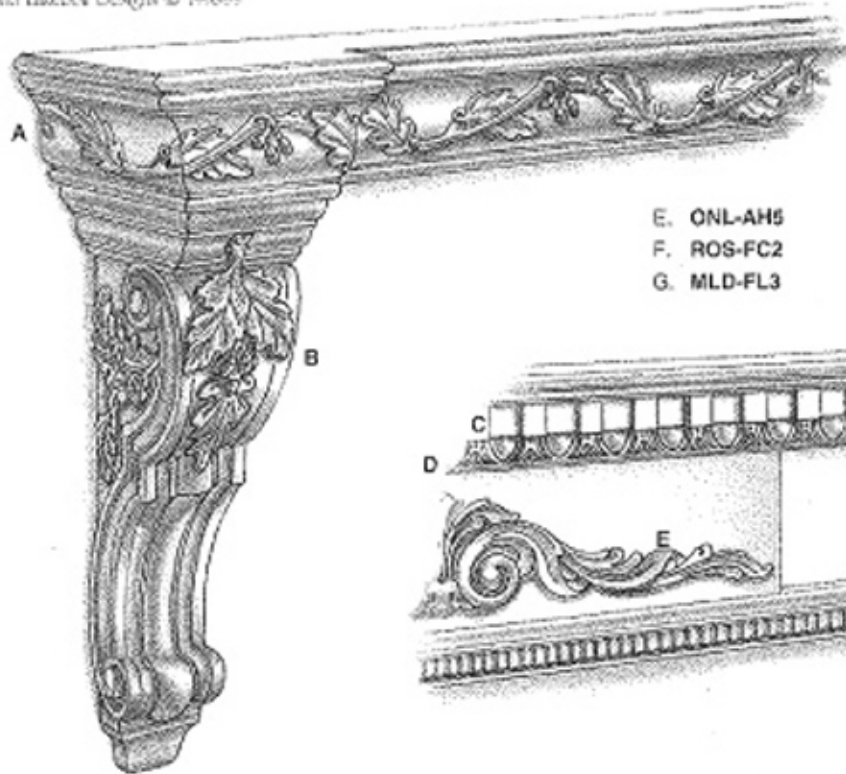

- A. MLD-OB6
- B. CBL-OO3
- C. MLD-DO3
- D. MLD-EO3

- E. ONL-AH5
- F. ROS-FC2
- G. MLD-FL3

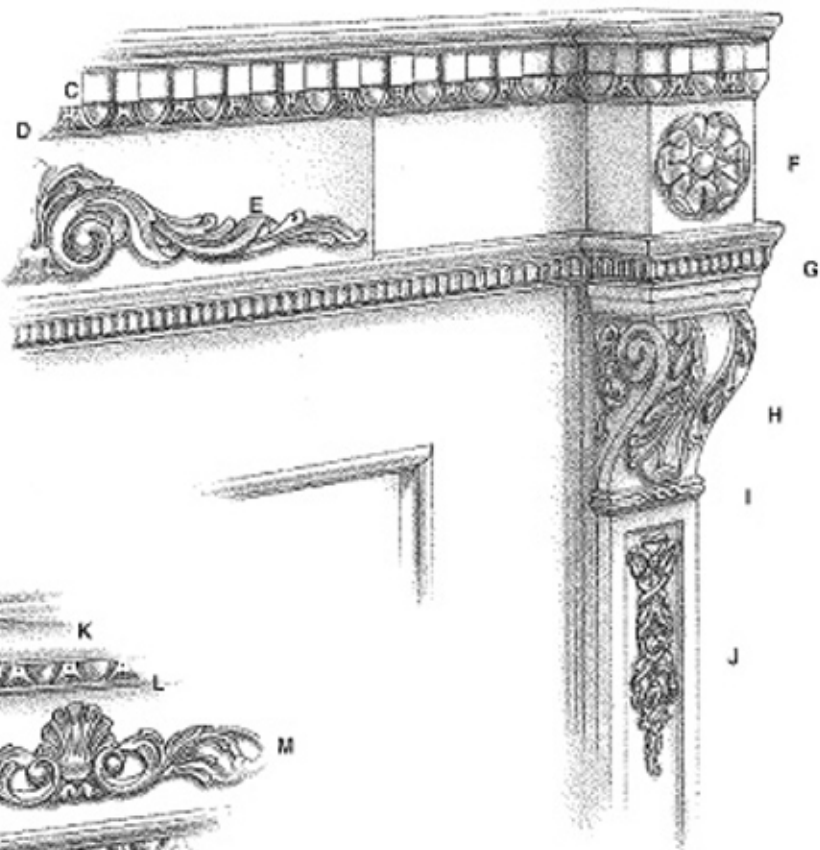

- H. CBL-AD3
- I. MLD-LA1
- J. ONL-FP3

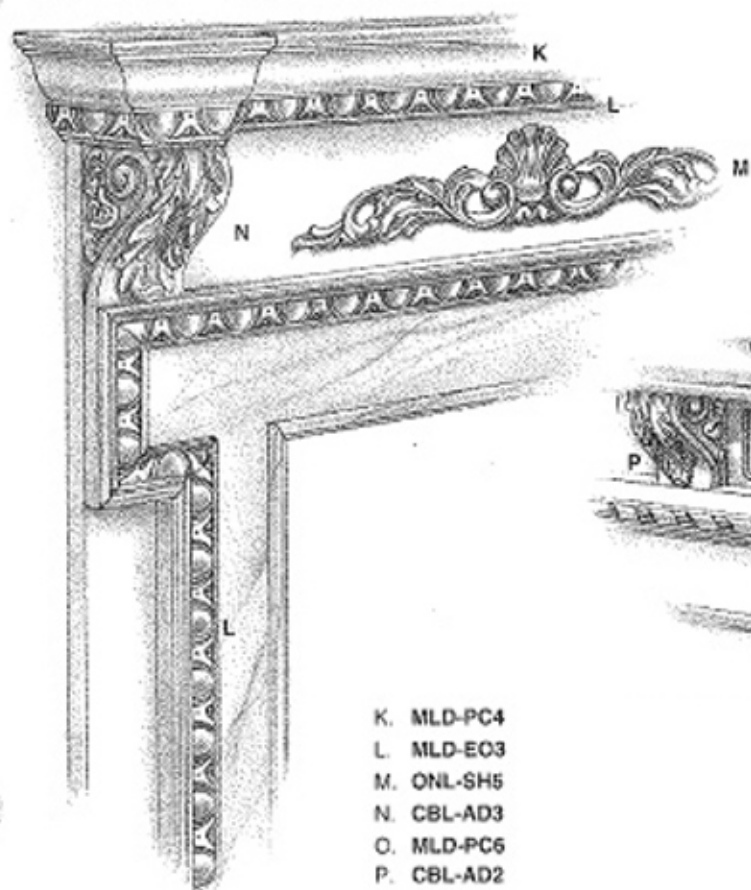

- K. MLD-PC4
- L. MLD-EO3
- M. ONL-SH5
- N. CBL-AD3

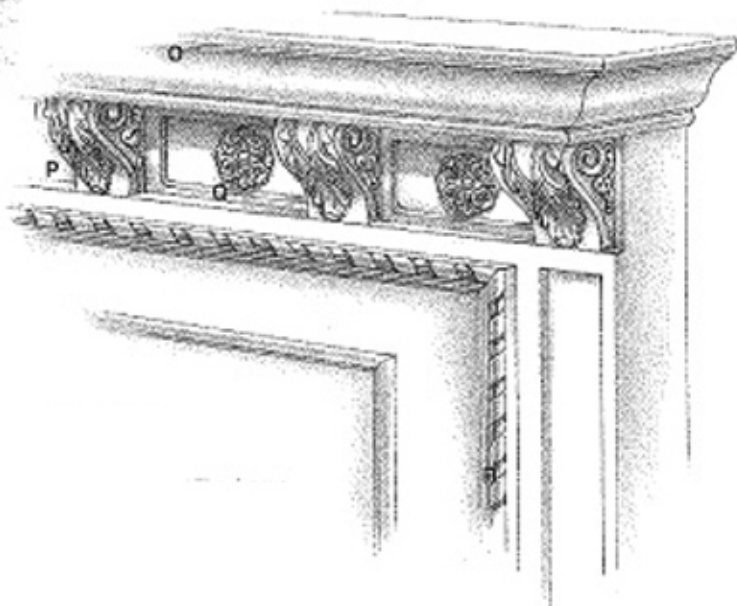

- O. MLD-PC6
- P. CBL-AD2
- Q. ROS-AC1
- R. MLD-BT1

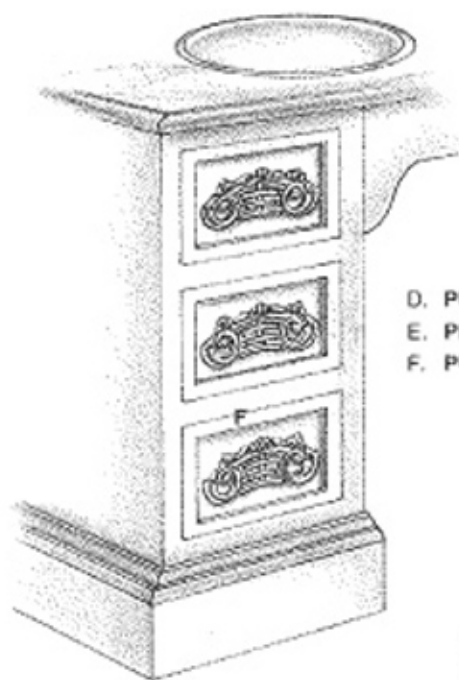

D. PUL-DR0
E. PNL-FW3
F. PUL-FO1

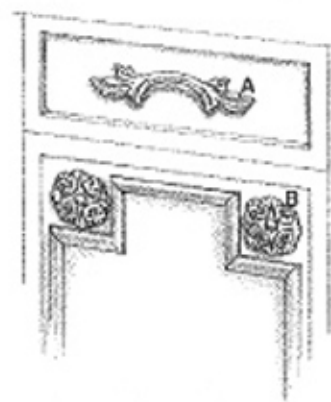

A. PUL-LH1
B. ROS-AC1
C. PUL-FO3

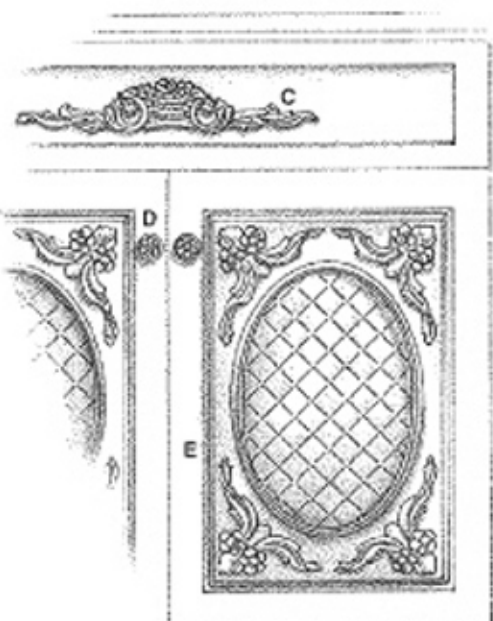

G. PNL-LM2
H. MLD-LC3

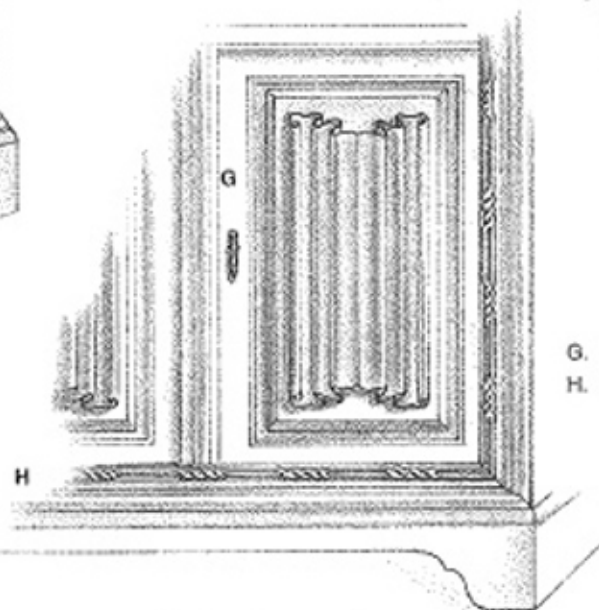

I. PUL-GO3
J. PNL-GW3
K. MLD-SP3
L. PUL-SO1



M. MLD-086
S. PNL-OW3

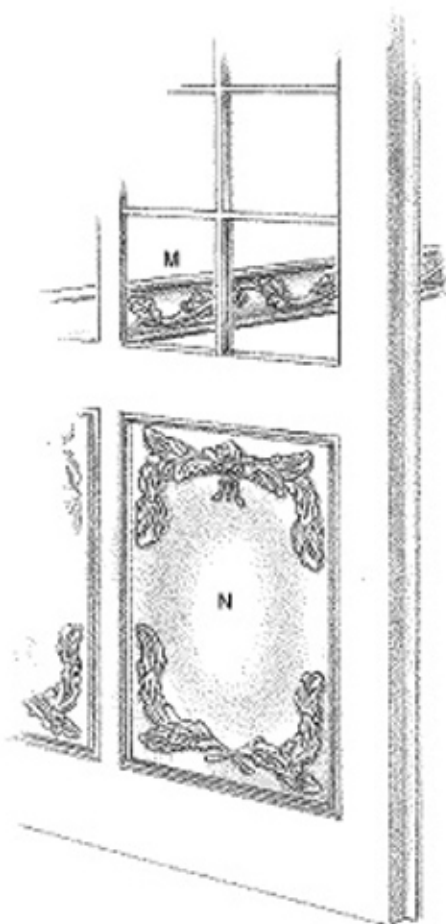

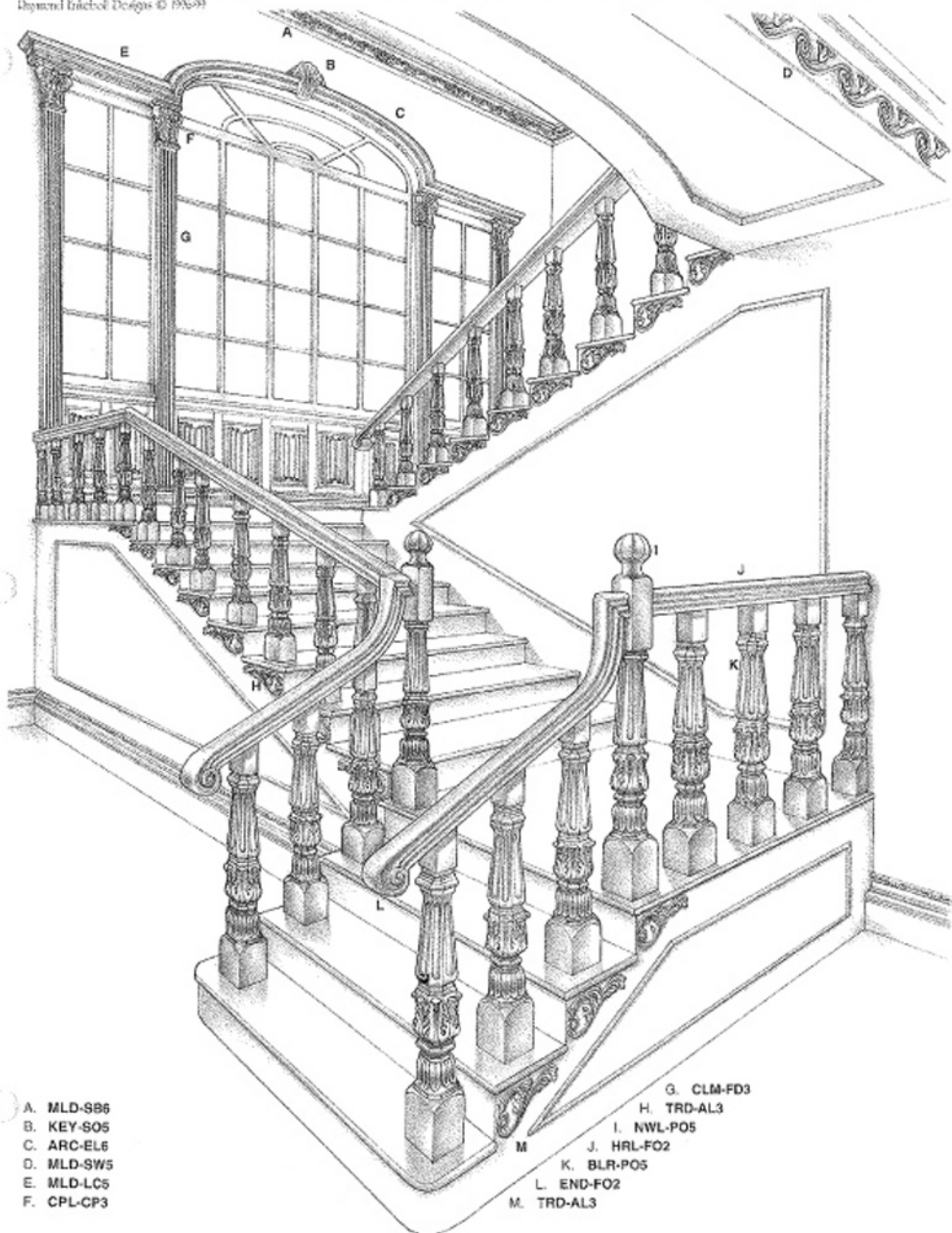

- A. MLD-SB6
- B. KEY-S05
- C. ARC-EL6
- D. MLD-SW5
- E. MLD-LC5
- F. CPL-CP3

- G. CLM-FD3
- H. TRD-AL3
- I. NWL-PO5
- J. HRL-FO2
- K. BLR-PO5
- L. END-FO2
- M. TRD-AL3

- A. NWL-G05
- B. BLR-G03
- C. MLD-GB6
- D. BLR-GF2
- E. NWL-AF5
- F. BLR-AF3
- G. MLD-FL3
- H. FIN-AO2

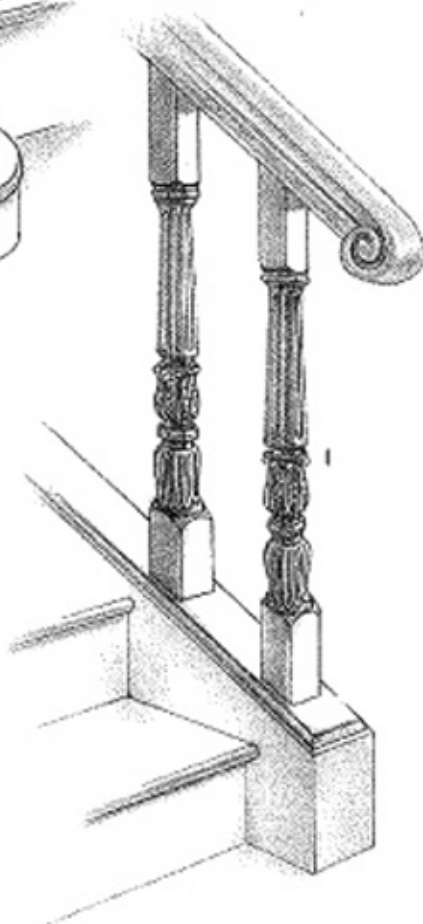
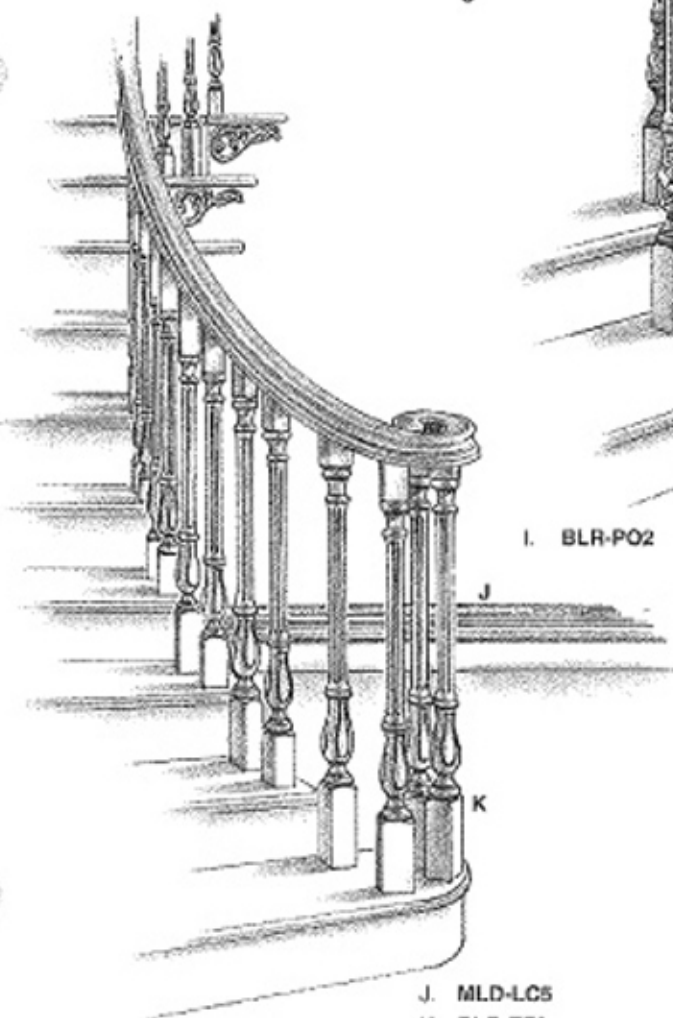
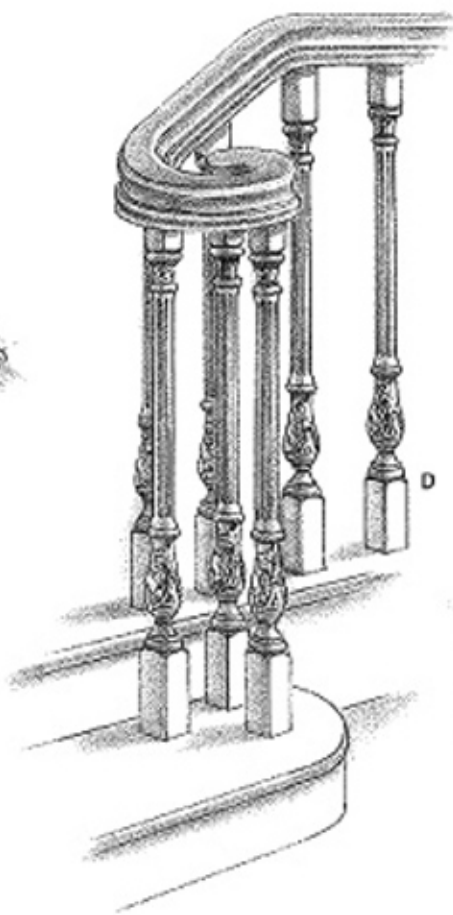
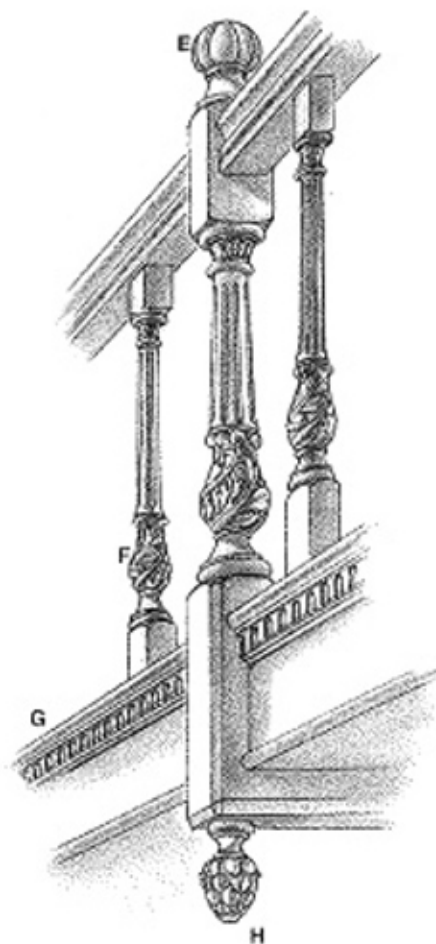
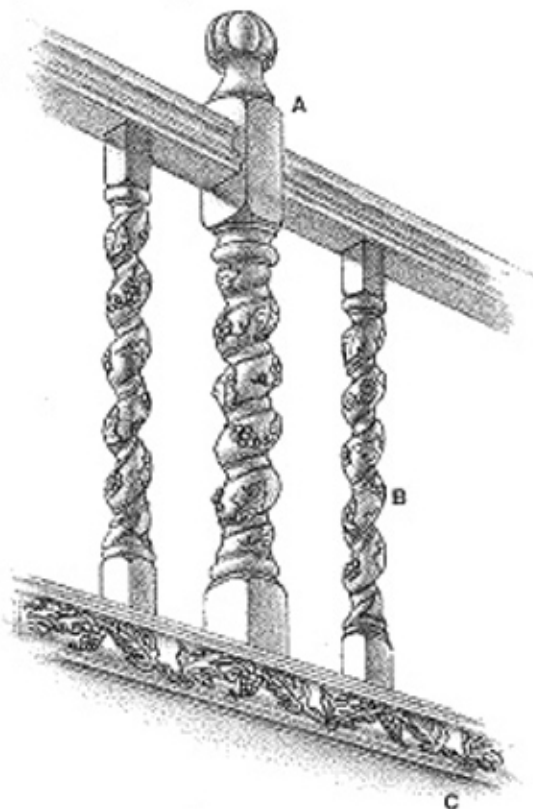

I. BLR-PO2

J. MLD-LC5
K. BLR-TF2

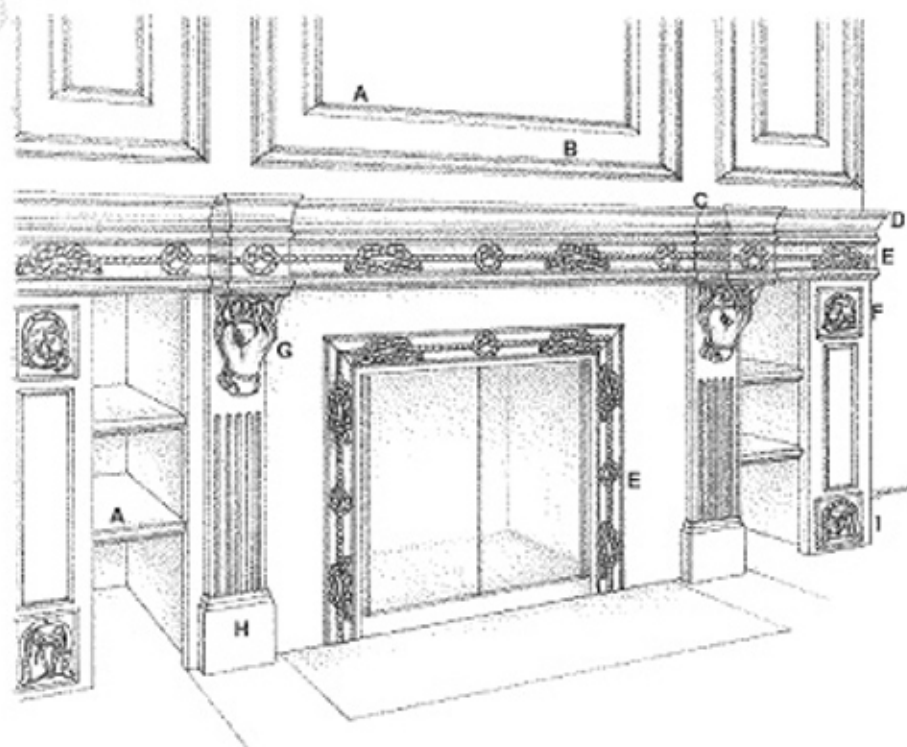

- A. MLD-PO1
- B. MLD-PO3
- C. MLD-PC6
- D. MLD-PO0
- E. MLD-ER4
- F. ONL-ET2
- G. CBL-HO2
- H. CLM-FP4

- I. ONL-ET3
- J. MLD-EB6
- K. MLD-EC6
- L. MTL-TF8
- M. ONL-EH4
- N. MLD-PO0
- O. MLD-PO1
- P. ONL-ET2
- Q. BAS-TO3
- R. BCK-SPT
- S. ONL-EH2
- T. ONL-EH1
- U. BLR-TF3

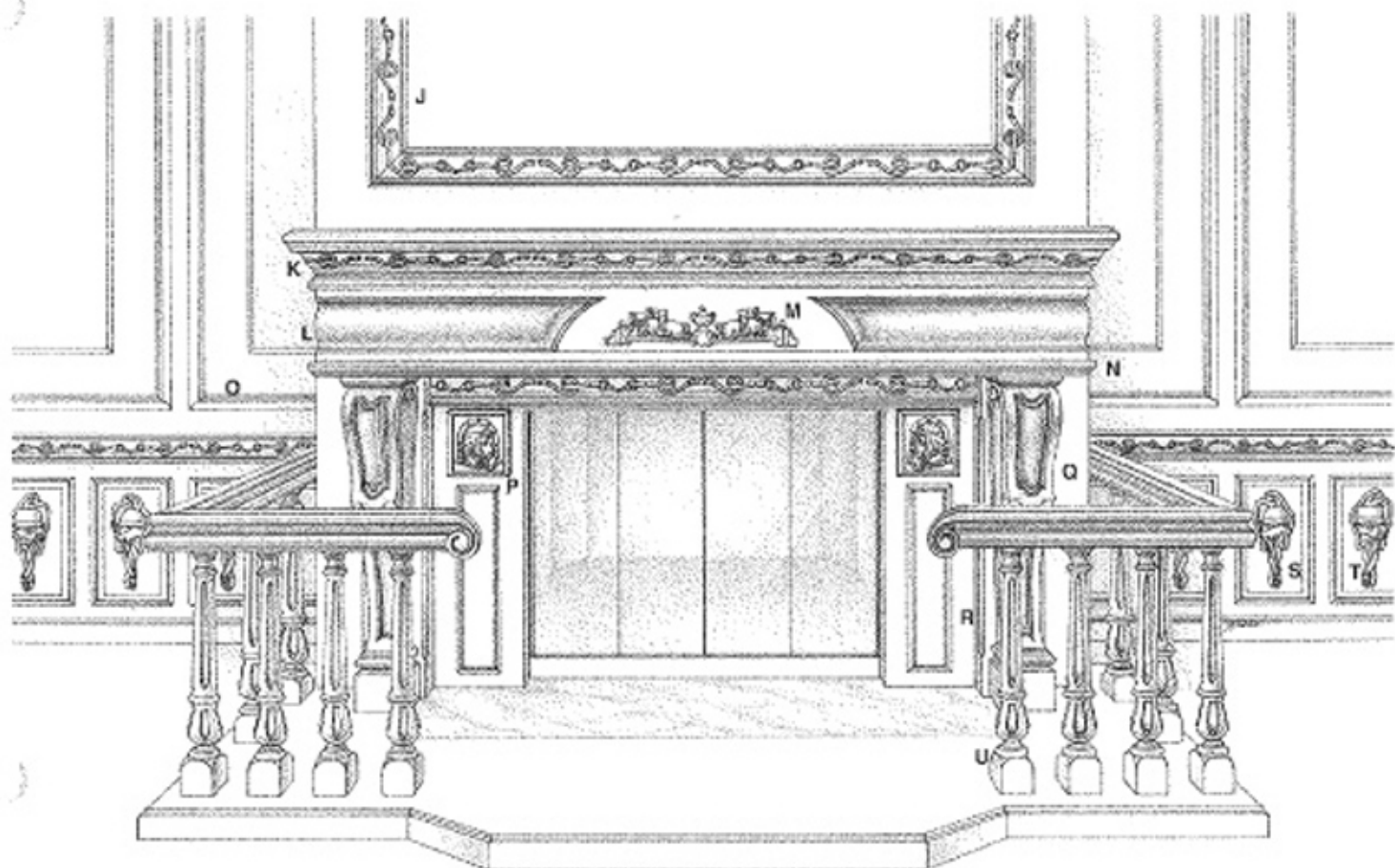

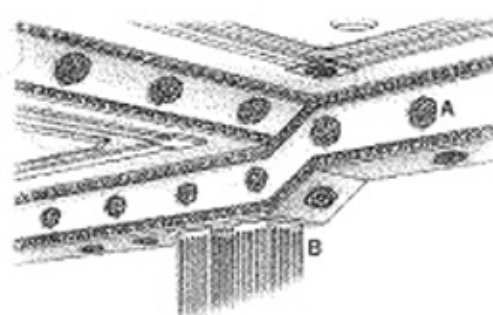

- A. ROS-AC2
- B. CLM-FS4
- C. ROS-FC2
- D. MLD-AB2
- E. CPL-CR4
- F. MLD-PC6
- G. ROS-ST2
- H. MLD-BO2

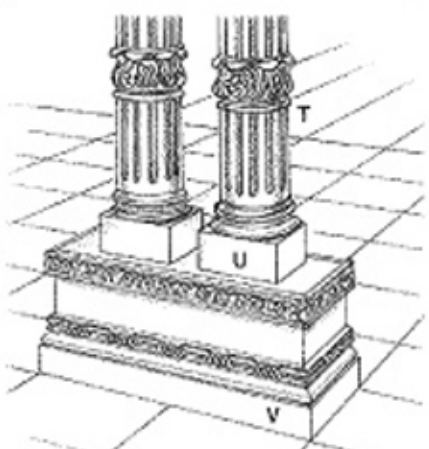
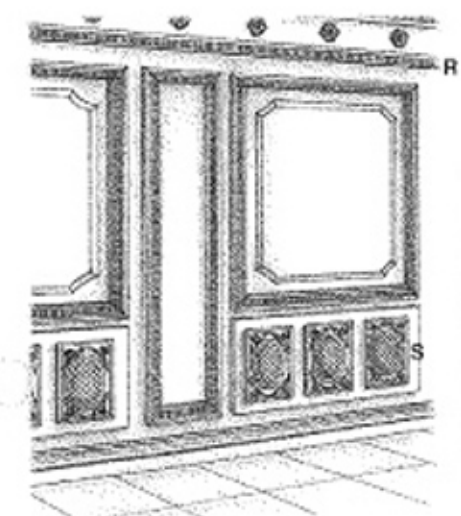
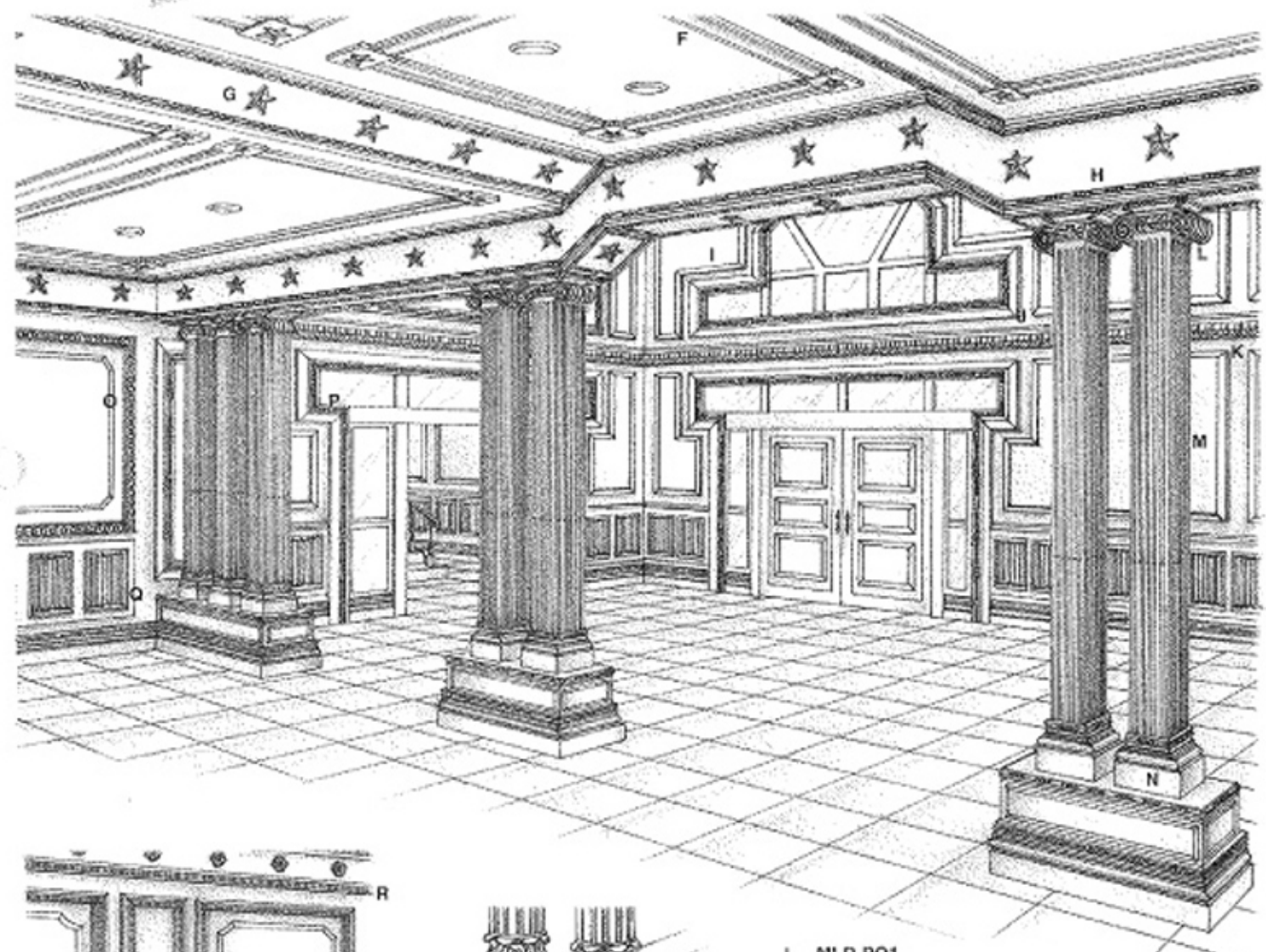
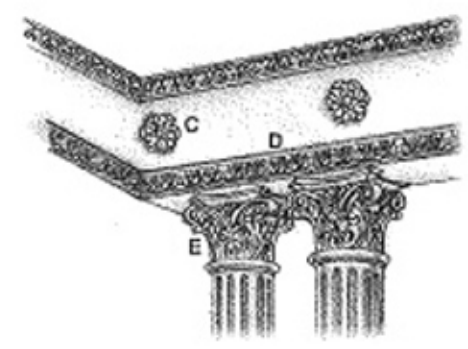

- I. MLD-PO1
- J. MLD-DO3
- K. MLD-EO3
- L. CPL-IO4
- M. CLM-FS4
- N. CLM-PB4
- O. MLD-EA3
- P. MLD-LA3
- Q. PNL-LW3
- R. MLD-FL3
- S. PNL-FW3
- T. CLM-AF4
- U. CLM-PP6
- V. MLD-LC5

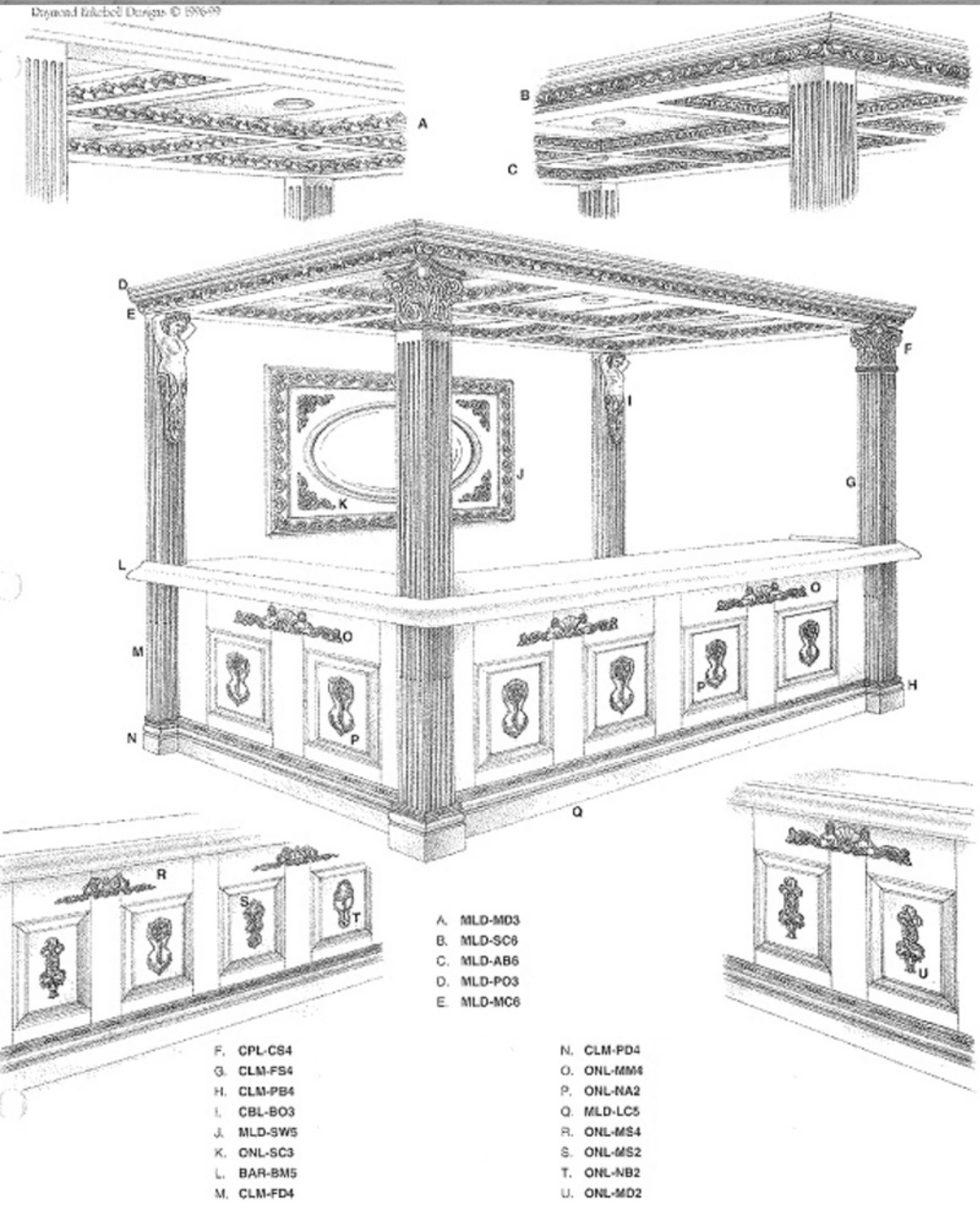

- A. MLD-MD3
- B. MLD-SC8
- C. MLD-AB6
- D. MLD-PO3
- E. MLD-MC6

- F. CPL-CS4
- G. CLM-FS4
- H. CLM-PB4
- I. CBL-BO3
- J. MLD-SW5
- K. ONL-SC3
- L. BAR-BM5
- M. CLM-FD4

- N. CLM-PD4
- O. ONL-MM4
- P. ONL-NA2
- Q. MLD-LC5
- R. ONL-MS4
- S. ONL-MS2
- T. ONL-NB2
- U. ONL-MD2

- A. MLD-PO2
- B. MLD-PC8
- C. MLD-AP4

- D. ONL-AC1
- E. CBL-LB2
- F. CLM-FP2

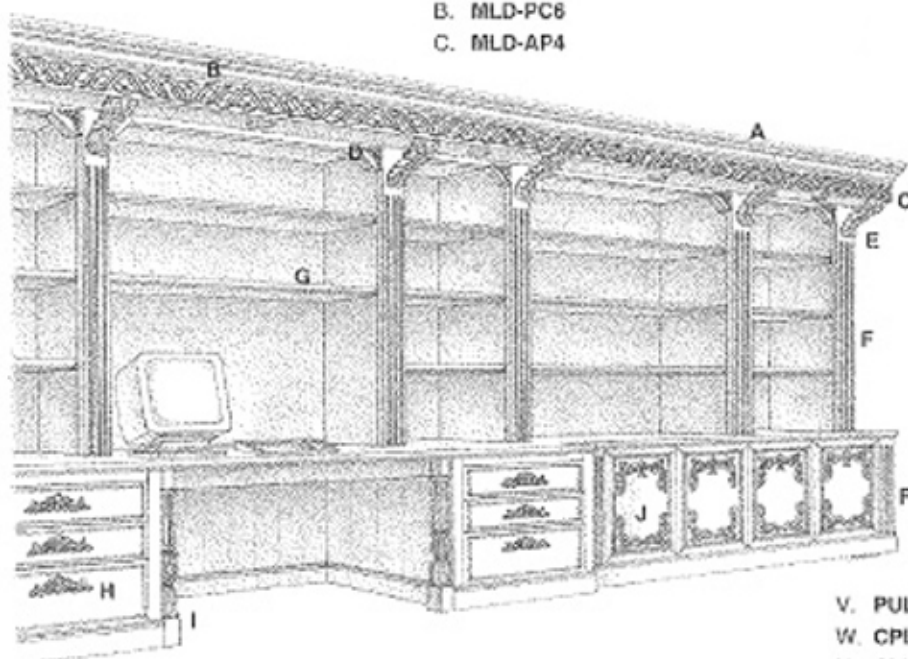

- G. MLD-PO1
- H. PUL-AO1
- I. BLR-PO3
- J. PNL-OW3
- K. MLD-PB9
- L. MLD-DO2
- M. MLD-PC9
- N. MLD-AB5
- O. ONL-AC2
- P. CRW-OO3
- Q. MLD-LC3
- R. PNL-LM3
- S. ONL-LF2
- T. MLD-PO1
- U. PUL-GR0

- V. PUL-AO1
- W. CPL-CR4
- X. CLM-AF4
- Y. CLM-PP6

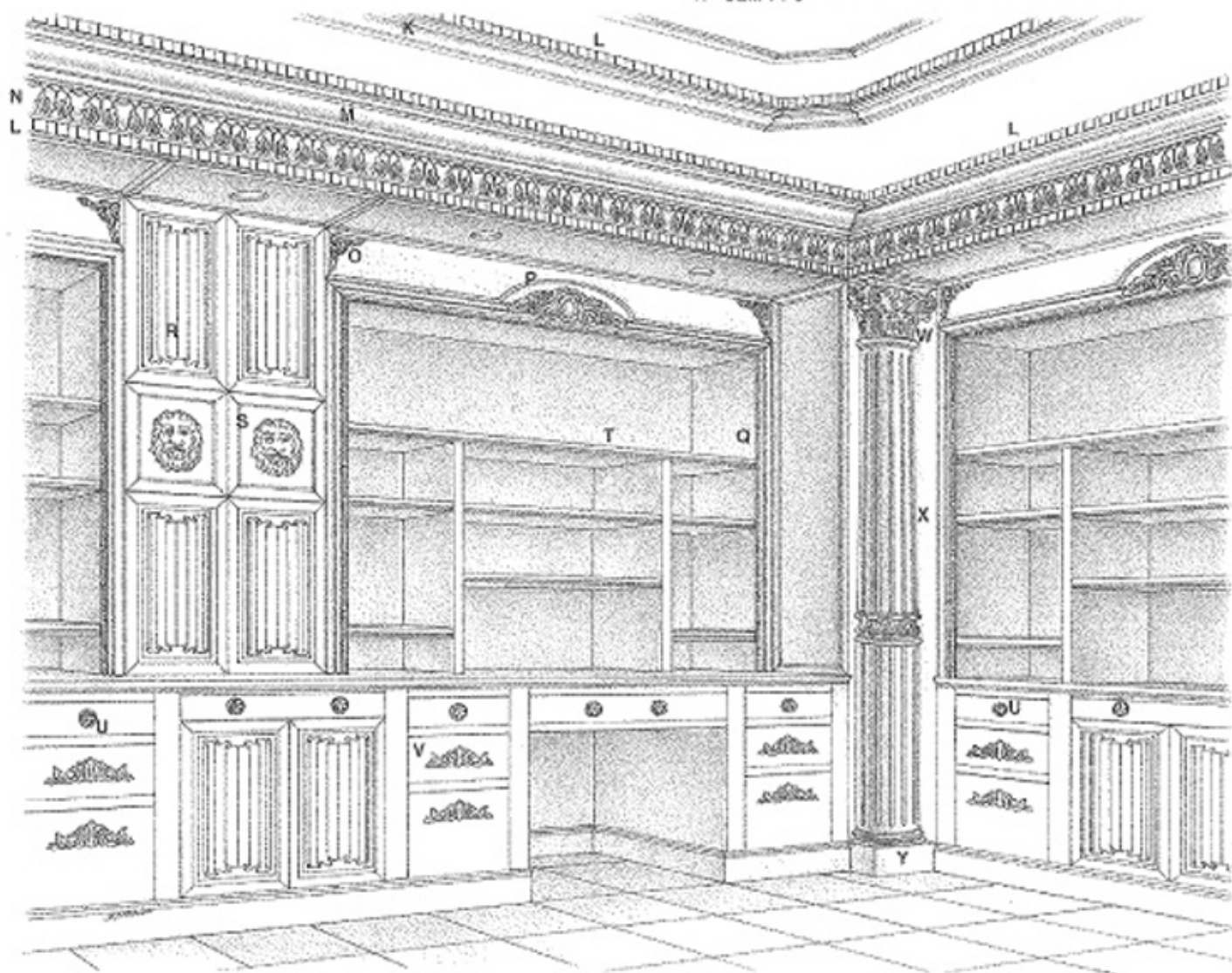

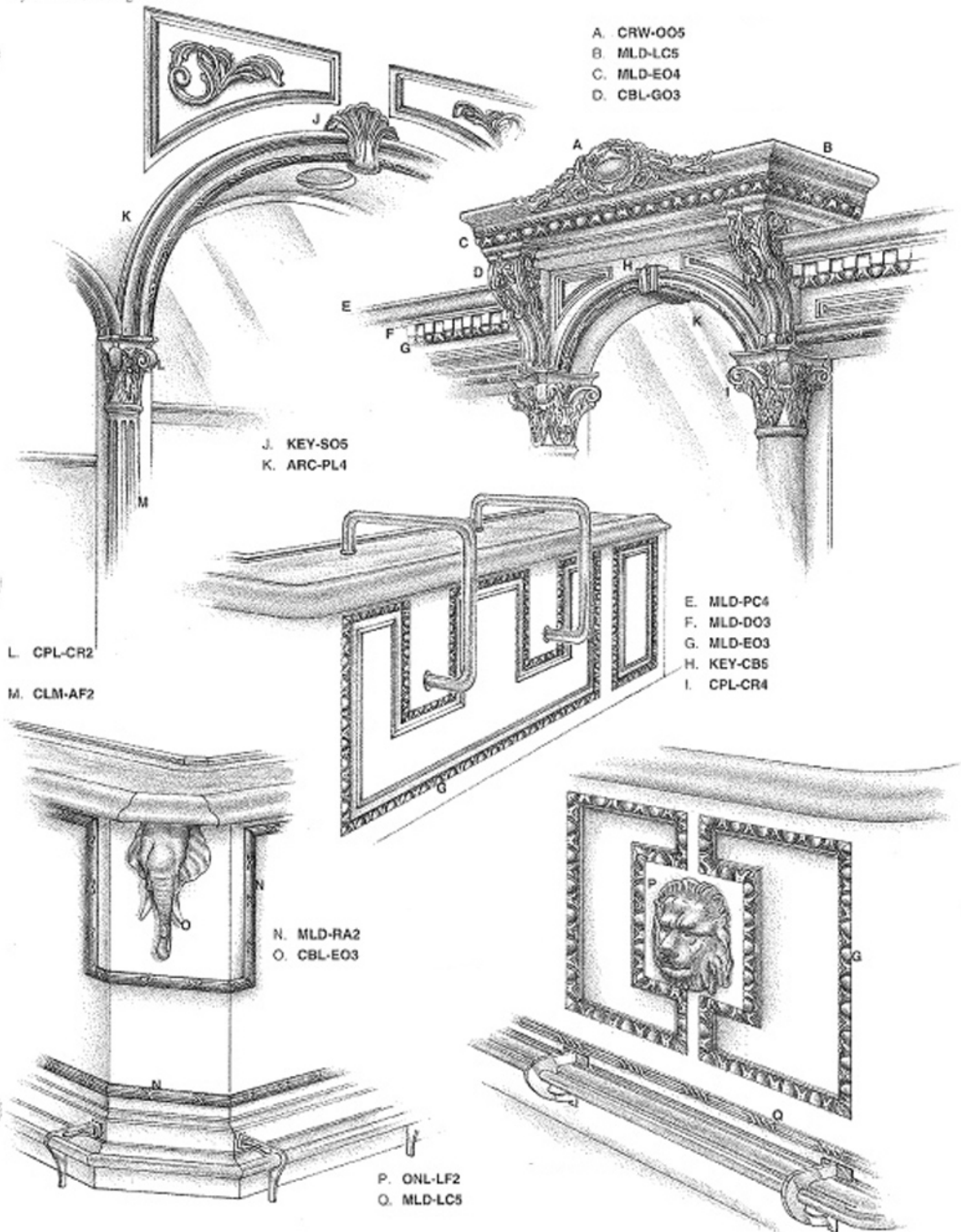

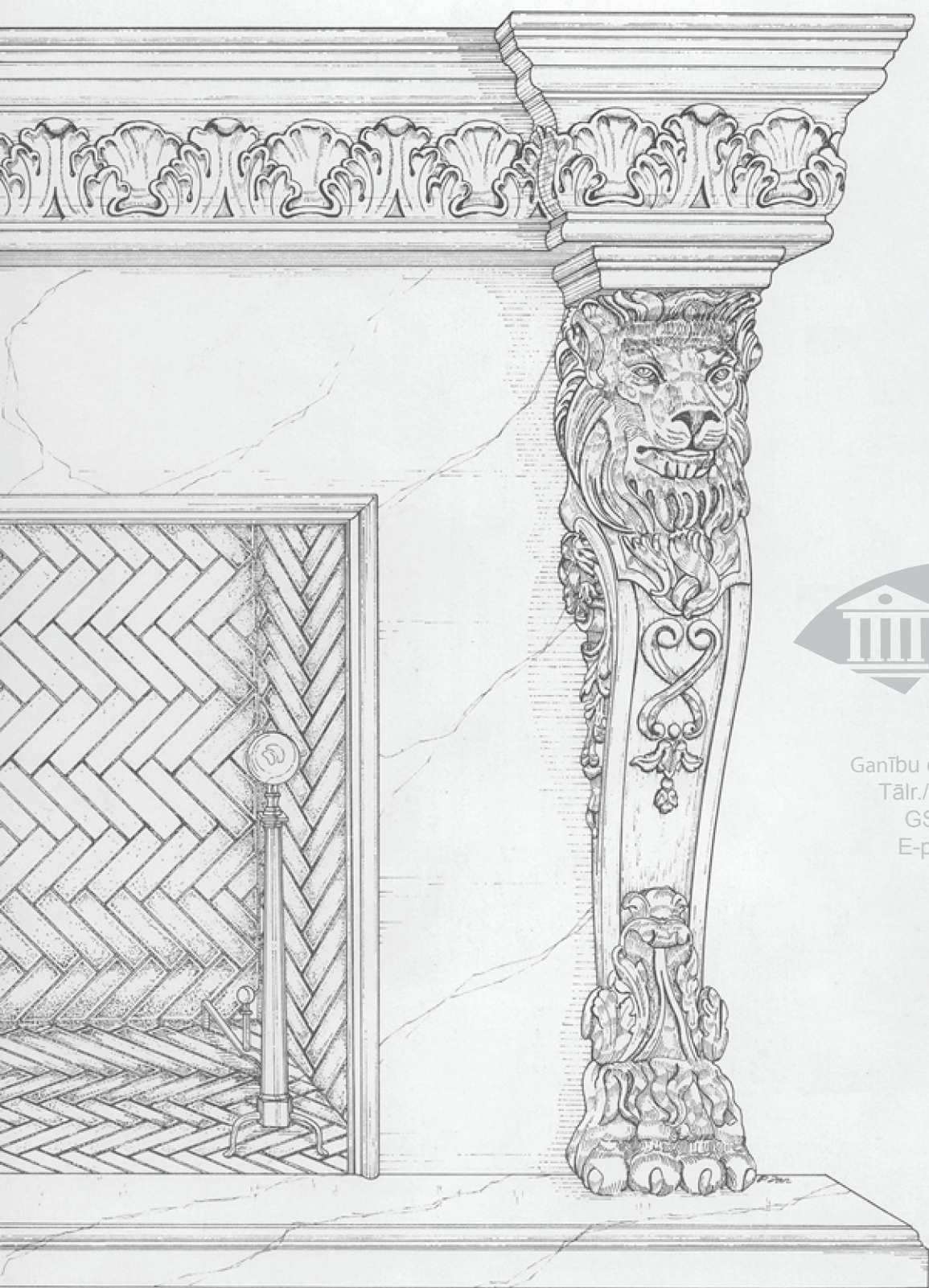

SIA "Botto Dizains"
Ganību dambis 31, Rīga LV 1005
Tāl./fakss: +371 67290356
GSM: +371 26470006
E-pasts: botto@botto.lv
www.botto.lv